



## Operating Instructions



Audio Multi-channel Receiver    SX-LX03  
Speaker System                    SSP-LX03

Blu-ray Disc Home Cinema System

LX03<sub>BD</sub>

Audio Multi-channel Receiver

SX-LX08

# IMPORTANT



The lightning flash with arrowhead symbol, within an equilateral triangle, is intended to alert the user to the presence of uninsulated "dangerous voltage" within the product's enclosure that may be of sufficient magnitude to constitute a risk of electric shock to persons.

## CAUTION

RISK OF ELECTRIC SHOCK  
DO NOT OPEN

**CAUTION:**  
TO PREVENT THE RISK OF ELECTRIC SHOCK, DO NOT REMOVE COVER (OR BACK). NO USER-SERVICEABLE PARTS INSIDE. REFER SERVICING TO QUALIFIED SERVICE PERSONNEL.



The exclamation point within an equilateral triangle is intended to alert the user to the presence of important operating and maintenance (servicing) instructions in the literature accompanying the appliance.

D3-4-2-1-1\_En-A

## WARNING

**This equipment is not waterproof. To prevent a fire or shock hazard, do not place any container filled with liquid near this equipment (such as a vase or flower pot) or expose it to dripping, splashing, rain or moisture.**

D3-4-2-1-3\_B\_En

This product complies with the Low Voltage Directive 2006/95/EC and EMC Directive 2004/108/EC.

D3-4-2-1-9a\_A\_En

## WARNING

*Before plugging in for the first time, read the following section carefully.*

**The voltage of the available power supply differs according to country or region. Be sure that the power supply voltage of the area where this unit will be used meets the required voltage (e.g., 230 V or 120 V) written on the rear panel.**

D3-4-2-1-4\_A\_En

If the AC plug of this unit does not match the AC outlet you want to use, the plug must be removed and appropriate one fitted. Replacement and mounting of an AC plug on the power supply cord of this unit should be performed only by qualified service personnel. If connected to an AC outlet, the cut-off plug can cause severe electrical shock. Make sure it is properly disposed of after removal. The equipment should be disconnected by removing the mains plug from the wall socket when left unused for a long period of time (for example, when on vacation).

D3-4-2-2-1a\_A\_En

## WARNING

**To prevent a fire hazard, do not place any naked flame sources (such as a lighted candle) on the equipment.**

D3-4-2-1-7a\_A\_En

## CAUTION

The STANDBY/ON switch on this unit will not completely shut off all power from the AC outlet. Since the power cord serves as the main disconnect device for the unit, you will need to unplug it from the AC outlet to shut down all power. Therefore, make sure the unit has been installed so that the power cord can be easily unplugged from the AC outlet in case of an accident. To avoid fire hazard, the power cord should also be unplugged from the AC outlet when left unused for a long period of time (for example, when on vacation).

D3-4-2-2-2a\_A\_En

## VENTILATION CAUTION

**When installing this unit, make sure to leave space around the unit for ventilation to improve heat radiation (at least 10 cm at top, 10 cm at rear, and 10 cm at each side).**

## WARNING

**Slots and openings in the cabinet are provided for ventilation to ensure reliable operation of the product, and to protect it from overheating. To prevent fire hazard, the openings should never be blocked or covered with items (such as newspapers, table-cloths, curtains) or by operating the equipment on thick carpet or a bed.**

D3-4-2-1-7b\_A\_En

## Operating Environment

Operating environment temperature and humidity: +5 °C to +35 °C (+41 °F to +95 °F); less than 85 %RH (cooling vents not blocked)

Do not install this unit in a poorly ventilated area, or in locations exposed to high humidity or direct sunlight (or strong artificial light)

D3-4-2-1-7c\_A\_En

Replacement and mounting of an AC plug on the power supply cord of this unit should be performed only by qualified service personnel.

### IMPORTANT: THE MOULDED PLUG

This appliance is supplied with a moulded three pin mains plug for your safety and convenience. A 5 amp fuse is fitted in this plug. Should the fuse need to be replaced, please ensure that the replacement fuse has a rating of 5 amps and that it is approved by ASTA or BSI to BS1362.

Check for the ASTA mark  or the BSI mark  on the body of the fuse.

If the plug contains a removable fuse cover, you must ensure that it is refitted when the fuse is replaced. If you lose the fuse cover the plug must not be used until a replacement cover is obtained. A replacement fuse cover can be obtained from your local dealer.

**If the fitted moulded plug is unsuitable for your socket outlet, then the fuse shall be removed and the plug cut off and disposed of safely. There is a danger of severe electrical shock if the cut off plug is inserted into any 13 amp socket.**

If a new plug is to be fitted, please observe the wiring code as shown below. If in any doubt, please consult a qualified electrician.

IMPORTANT: The wires in this mains lead are coloured in accordance with the following code:

Blue : Neutral    Brown : Live

As the colours of the wires in the mains lead of this appliance may not correspond with the coloured markings identifying the terminals in your plug, proceed as follows :

The wire which is coloured BLUE must be connected to the terminal which is marked with the letter **N** or coloured BLACK.

The wire which is coloured BROWN must be connected to the terminal which is marked with the letter **L** or coloured RED.

**How to replace the fuse:** Open the fuse compartment with a screwdriver and replace the fuse.

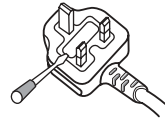

D3-4-2-1-2-2\_B\_En

### Information for users on collection and disposal of old equipment and used batteries

(Symbol for  
equipment)



These symbols on the products, packaging, and/or accompanying documents mean that used electrical and electronic products and batteries should not be mixed with general household waste.

For proper treatment, recovery and recycling of old products and used batteries, please take them to applicable collection points in accordance with your national legislation.

(Symbol examples  
for batteries)



By disposing of these products and batteries correctly, you will help to save valuable resources and prevent any potential negative effects on human health and the environment which could otherwise arise from inappropriate waste handling.

For more information about collection and recycling of old products and batteries, please contact your local municipality, your waste disposal service or the point of sale where you purchased the items.



Pb

**These symbols are only valid in the European Union.**

**For countries outside the European Union:**

If you wish to discard these items, please contact your local authorities or dealer and ask for the correct method of disposal.

K058\_B\_En

This product is for general household purposes. Any failure due to use for other than household purposes (such as long-term use for business purposes in a restaurant or use in a car or ship) and which requires repair will be charged for even during the warranty period.

K041\_En

### POWER-CORD CAUTION

Handle the power cord by the plug. Do not pull out the plug by tugging the cord and never touch the power cord when your hands are wet as this could cause a short circuit or electric shock. Do not place the unit, a piece of furniture, etc., on the power cord, or pinch the cord. Never make a knot in the cord or tie it with other cords. The power cords should be routed such that they are not likely to be stepped on. A damaged power cord can cause a fire or give you an electrical shock. Check the power cord once in a while. When you find it damaged, ask your nearest PIONEER authorized service center or your dealer for a replacement. **5002\_En**

Thank you for buying this Pioneer product.

Please read through these operating instructions so that you will know how to operate your model properly. After you have finished reading the instructions, put them in a safe place for future reference.

# Contents

## ❖ Section One

What's in the box.....6

### 01 Controls and displays

Remote control .....7

Putting the batteries in  
the remote control.....9

Using the remote control.....9

Receiver.....10

Front panel .....10

Display .....11

Rear panel.....13

Blu-ray disc player.....14

Front Panel .....14

Display .....14

Rear Panel .....15

### 02 Speaker Setup Guide (LX03BD)

Safety precautions when setting up.....16

Home theater sound setup .....16

Standard surround setup .....16

Front surround setup.....16

Preparing the speakers .....17

Using the supplied speaker stands.....18

Wall mounting the speakers .....19

Additional notes on speaker placement .19

Connect the speakers .....20

Using your own speaker cables.....22

### 02 Speaker Setup Guide (SX-LX08)

Safety precautions when setting up.....24

Home theater sound setup .....24

Connect the speakers .....24

### 03 Connecting up

Basic connections .....26

### 04 Getting started

Using the Auto MCACC setup for optimal  
surround sound .....29

### 05 Listening to your system

Auto listening mode .....31

Listening in surround sound .....31

Dolby Pro Logic II Music settings .....32

Using Advanced Surround .....32

Using Front Stage Surround Advance...33

Listening in stereo.....33

Listening with headphones.....33

Using the Sound Retriever .....33

Listening with Acoustic Calibration EQ...34

Enhancing dialogue .....34

Using Midnight and Quiet listening modes .34

Adjusting the bass and treble .....35

Boosting the bass level.....35

Adjusting sound delay.....35

### 06 Connecting an iPod

Connecting your iPod to this unit .....36

iPod playback .....36

### 07 Listening to the radio

Listening to the radio .....39

Improving poor FM reception .....39

Improving poor AM sound .....39

Changing the noise cut mode.....40

Memorizing stations.....40

Listening to station presets.....40

Using RDS .....41

Displaying RDS information .....41

Searching for RDS programs .....41

## Section One

### 08 Surround sound settings

Using the Sound Setup menu .....	42
Effective Sound (for optimum sound) ..	42
Channel level setting .....	43
Speaker distance setting .....	43
Dynamic Range Control .....	44
Dual mono setting .....	44
Virtual Surround Back .....	44
LFE Attenuate .....	45
DTS CD setting .....	45

### 09 Other connections

Using this unit for TV audio .....	46
Audio input settings from the TVs (TV Input) .....	46
Listening to the sound of an external device on this receiver .....	47
Connecting for digital audio .....	47
Connecting an analog audio component .....	47
Listening to an external audio source ..	47
Outputting the sound of this receiver to an external device .....	48
Line Output setting .....	48
Connecting external antennas .....	49
About control out connections .....	49
Connecting using HDMI .....	50
Switching the HDMI audio setting .....	51
Setting the Auto Delay .....	51
Resetting the HDMI connection .....	52
About HDMI .....	52

### 10 HDMI Control

Making the HDMI Control connections ..	53
Setting the HDMI options .....	55
Setting the HDMI Control mode .....	55
Before using synchronization .....	55
Synchronized amp mode .....	55
Synchronized amp mode operations ...	55
Canceling synchronized amp mode ...	55

### 11 Additional information

Optional system settings .....	56
Setting the sleep timer .....	56
Dimming the display .....	56
Changing the display mode .....	57
Key lock setting .....	57
Setting up the remote to control your TV ..	57
TV Preset code list .....	58
Surround sound formats .....	58
Dolby .....	58
Dolby Digital .....	58
Dolby Pro Logic II and Dolby Surround ..	58
DTS .....	59
DTS Digital Surround .....	59
Installation and maintenance .....	59
Hints on installation .....	59
Troubleshooting .....	60
General .....	60
Tuner .....	62
HDMI connection .....	62
Front panel display messages .....	62
Resetting the system .....	64
Specifications (LX03BD model) .....	65
Specifications (SX-LX08 model) .....	66

### ❖ Section Two

### Operating instructions for Blu-ray disc player (BDP-LX08) ..... 68 |

### What's in the box

Please confirm that the following items are all supplied.

#### LX03BD model

##### *Receiver box:*

- Remote control
- AA/R6 dry cell batteries (to confirm system operation) x2
- AM loop antenna
- FM antenna
- Microphone (for Auto MCACC setup)
- Power cords x2
- HDMI cables x2
- Speaker cable adaptors x5
- Cleaning cloth\*
- Warranty card
- Setup Guide
- These operating instructions

##### *Speakers box:*

- Speakers (front x2, center x2, surround x2)
- Subwoofer
- Speaker cables x7
- Brackets x2
- Screws (for brackets) x4
- Speaker stands x2
- Non-skid pads (for satellite speakers) x24
- Non-skid pads (for subwoofer) x4
- Non-skid pads (for speaker stands) x8
- Spiral wrap x2

#### SX-LX08 model

- Remote control
- AA/R6 dry cell batteries (to confirm system operation) x2
- AM loop antenna
- FM antenna
- Microphone (for Auto MCACC setup)
- Power cords x2
- HDMI cables x2
- Speaker cable adaptors x5
- Cleaning cloth\*
- Warranty card
- Setup Guide
- These operating instructions

\*When cleaning the cabinet, use the provided cleaning cloth.

Do not allow alcohol, thinner, benzene, or insecticides to come into contact with the surface, since finish discoloration may occur.

Chapter 1

# Controls and displays

## Remote control

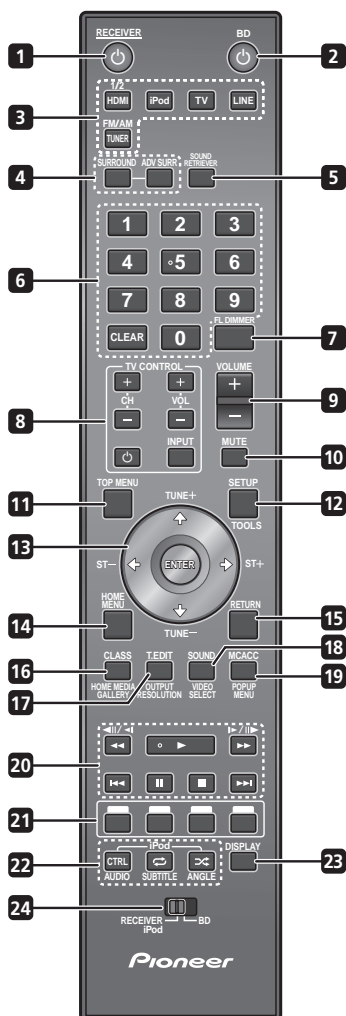

- Remote control unit buttons indicated with blue lettering (buttons indicated with asterisk (\*) in this section) are used to operate an optional Pioneer Blu-ray disc player. Set the remote control operation selector switch to **BD** to perform such operations.

**1** **RECEIVER**

Switches the receiver on or into standby.

**2** **BD**

Switches the Blu-ray disc player on or into standby.

**3 Input select buttons**

Use to select an input source.

See the section *Audio input settings from the TVs (TV Input)* on page 46 for information regarding the **TV** button.

**4 Sound controls**

**SURROUND**

Selects a Surround mode (page 31) or switches to stereo playback (page 33).

**ADV SURR**

Selects a Pioneer original surround mode (page 32).

**5 SOUND RETRIEVER**

Press to restore CD quality sound to compressed audio sources (page 33).

**6 Number buttons**

Use to enter a track number or radio station.

**7 FL DIMMER\***

Press to switch the brightness of the Blu-ray disc player's display. The **FL OFF** indicator lights when **Off** is selected.

**8 TV CONTROL buttons**

These control Pioneer Flat Screen TVs.

**9 VOLUME +/-**

Adjusts the volume.

**10 MUTE**

Mutes the sound (press again to cancel).

**11 TOP MENU**

Press to return to the iPod Top menu when using iPod functions.

After set the remote control operation switch to **BD**, press to displays the player's top menu of a BD-ROM, or DVD-Video disc.

**12 SETUP**

Use to make various system and surround sound settings (page 42, 51, 56).

**TOOLS\***

Press to display/hide the **TOOLS** menu.

**13 ↑/↓/←/→ (TUNE +/-, ST +/-), ENTER**

Use to select/switch system settings and modes, and to confirm actions.

Use **TUNE +/-** to find radio frequencies and use **ST +/-** to find preset stations.

**14 HOME MENU\***

Press to display/hide the Home Menu.

**15 RETURN**

Press to return to the previous screen.

**16 CLASS**

Switches between the three banks (classes) of radio station presets (page 40).

**HOME MEDIA GALLERY\***

Press to display/hide the Home Media Gallery screen.

**17 T.EDIT**

Memorizes stations for recall (page 40).

**OUTPUT RESOLUTION\***

Use to switch the output video resolution from the player's **HDMI OUT** or **COMPONENT VIDEO** output terminals.

**18 SOUND**

Accesses the sound menu to adjust the tone, bass and treble, etc. (page 32, 34).

**VIDEO SELECT\***

Press to switch the player's terminal from which the video signals are output. Use to switch between digital output (**HDMI OUT** terminal) and analog output (**COMPONENT VIDEO, S-VIDEO** or **VIDEO** output terminals) (**the signals are only output from the selected video output terminal**).

**19 MCACC**

Starts the Auto MCACC setup (page 29).

**POPOP MENU\***

Press to display the BD-ROM or DVD-Video menus.

**20 Playback controls**

See *iPod playback* on page 36 and *Playing discs or files* on page 90 for an explanation of these controls.

**21 Color (red/green/yellow/blue) buttons**

Use these to navigate BD-ROM menus.

**22 iPod controls:****CTRL**

Switches between the iPod controls and the receiver controls.



Changes repeat play setting.



Changes shuffle play setting.

**BD/DVD controls:****AUDIO\***

Press to switch the audio streams/channels.

**SUBTITLE\***

Press to switch the subtitles.



## ANGLE\*

Press to switch the BD-ROM or DVD-Video camera angles.

## 23 DISPLAY

Displays RDS information (page 41).

Displays song playback information when using the iPod function.

After set the remote control operation switch to **BD**, press to display the disc information.

## 24 Remote control operation selector switch

Set to **RECEIVER iPod** to operate this system or iPod, **BD** to operate the Blu-ray disc player.

## Putting the batteries in the remote control

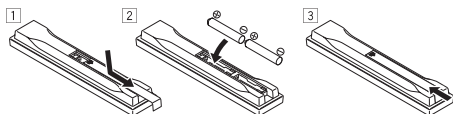

- 1 Open the battery compartment cover on the back of the remote control.
- 2 Insert two AA/R6 batteries into the battery compartment following the indications (+, -) inside the compartment.
- 3 Close the cover.



## Caution

Incorrect use of batteries can result in hazards such as leakage and bursting. Please observe the following:

- Don't mix new and old batteries together.
- Don't use different kinds of battery together — although they may look similar, different batteries may have different voltages.
- Make sure that the plus and minus ends of each battery match the indications in the battery compartment.

- Remove batteries from equipment that isn't going to be used for a month or more.
- When disposing of used batteries, please comply with governmental regulations or environmental public instruction's rules that apply in your country/area.
- Do not use or store batteries in direct sunlight or other excessively hot place, such as inside a car or near a heater. This can cause batteries to leak, overheat, explode or catch fire. It can also reduce the life or performance of batteries.

## Using the remote control

Please keep in mind the following when using the remote control:

- Make sure that there are no obstacles between the remote and the remote sensor on the unit.
- Remote operation may become unreliable if strong sunlight or fluorescent light is shining on the unit's remote sensor.
- Remote controllers for different devices can interfere with each other. Avoid using remotes for other equipment located close to this unit.
- Replace the batteries when you notice a fall off in the operating range of the remote.
- Use within the operating range in front of the remote control sensor on the display unit, as shown.

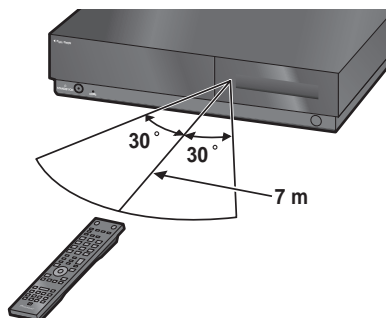

## Receiver

### Front panel

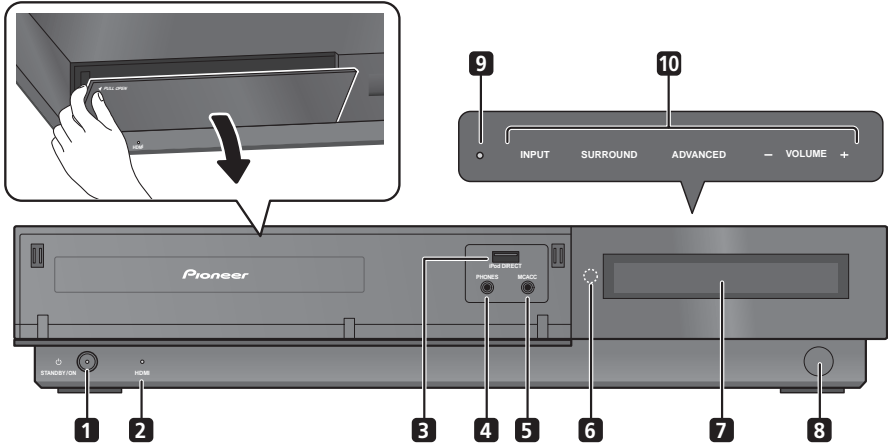

- Open the front door flap when using the front panel connectors.

#### 1 **⏻ STANDBY/ON**

Switches the system on or into standby.

#### 2 **HDMI indicator (Red)**

Lights when this system is connected to HDMI (HDCP) compatible component.

Also lights during initialization, after you plug this unit into an AC outlet.

#### 3 **iPod DIRECT terminal**

Use to connect your Apple iPod as an audio source for playback (page 36).

#### 4 **PHONES jack**

Connect headphones.

#### 5 **MCACC jack**

Use to connect the supplied microphone for the Auto MCACC setup (page 29).

#### 6 **IR remote sensor**

#### 7 **Front panel display**

See *Display* below for details.

#### 8 **Motion sensor**

When the front panel display is off, if Display Mode is set to **Auto Display**, the display will automatically turn on when movement is detected by the motion sensor (page 57).

#### 9 **Action indicator**

Lights when a touch sensor operation is performed.

## 10 Touch sensor

Touch sensor is on top of the unit.

Lightly touch the displayed words or symbols to operate controls.

### INPUT

Selects the source you want to listen to (**Digital 1 to Digital 3, Analog, iPod, HDMI 1 or HDMI 2**).

### SURROUND

Selects a Surround mode (page 31) or switches to stereo playback (page 33).

### ADVANCED

Selects a Pioneer original surround mode (page 32).

### VOLUME +/-

Use to adjust the volume.

## Using the motion sensor

This system features a motion sensor. Install it in a location that will be able to sense the movement of people near by.

The motion sensor detects movement in the left/right and up/down directions within a distance of 2.5 m and an angle of 40° (20° only in the upper direction). Walking towards the unit will reduce the sensing range to 0.7 m.

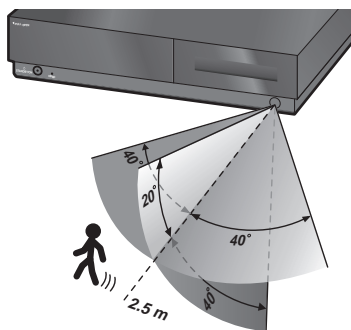

## Display

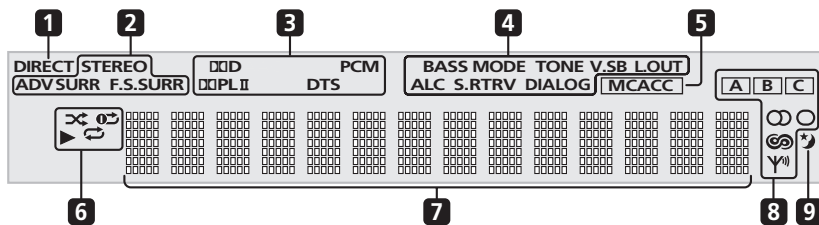

### 1 DIRECT

Lights when Direct Sound is selected (i.e. Effective Sound is off) (page 42).

### 2 Listening mode indicators

#### STEREO

Lights when the Stereo mode is selected or when a stereo source is being played back in the Auto listening mode (page 31).

### ADV SURR

Lights when one of the Advanced Surround listening modes is selected (page 32).

### F.S.SURR

Lights when one of the Front Stage Surround Advance listening modes is selected (page 33).

### 3 Digital format indicators

#### **D**

Lights during playback of a Dolby Digital source (page 31).

#### **PLII**

Lights during Dolby Pro Logic II decoding (page 32).

#### **PCM**

Lights during playback of PCM signals.

#### **DTS**

Lights during playback of a DTS source (page 31).

### 4 Sound processing indicators

#### **BASS MODE**

Lights when Bass Mode is active (page 35).

#### **TONE**

Lights when any of the Midnight, Quiet or tone controls feature is selected (page 35).

#### **V.SB**

Lights when Virtual Surround Back mode is active (page 44).

#### **L.OUT**

Lights when Line Output is set to **Lt/Rt** (page 48).

#### **ALC**

Lights when listening mode is set to **A.L.C.** (page 31).

#### **S.RTRV**

Lights when Sound Retriever is active (page 33).

#### **DIALOG**

Lights when Dialogue Enhancement is active (page 34).

### 5 MCACC

Lights when Acoustic Calibration EQ is active (page 34).

Blinks during Auto MCACC Setup (page 29).

### 6 iPod indicators



Lights during playback, and flashes during pause mode.



Lights during shuffle play.



Lights during repeat play.



Lights during 1-track repeat play.

### 7 Character display

### 8 Tuner indicators



Lights when a broadcast is being received.



Lights when a stereo FM broadcast is being received in auto stereo mode.



Lights when FM mono reception is selected.



Lights when in one of the RDS display or search modes.

#### **A, B, C**

Indicate the class of tuner function.

### 9

Lights when sleep timer is active (page 56).

## Rear panel

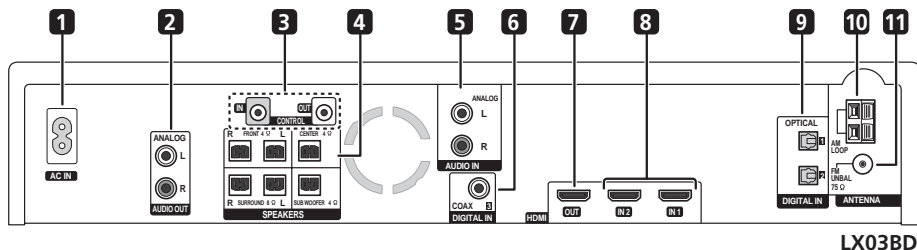

LX03BD

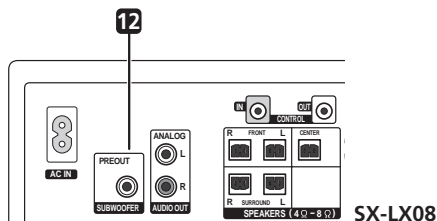

SX-LX08

### 1 AC IN – Power inlet

### 2 AUDIO OUT (ANALOG) jacks

Connect to the other audio component.

### 3 CONTROL IN/OUT jacks

Use to connect other Pioneer components so that you can control all your equipment from a single IR remote sensor.

### 4 SPEAKERS terminals

Match the colors of the speaker cables to their respective connectors.

### 5 AUDIO IN (ANALOG) jacks

Handle sound from an external component by using stereo audio cable. To listen to analog audio, change the input to **Analog**.

### 6 DIGITAL IN3 (COAX) jack

To listen to coaxial digital audio, change the input to **Digital 3 COAX**.

### 7 HDMI OUT connector

Connect to a television that has an HDMI terminal.

### 8 HDMI IN1/2 connectors

Use high-quality audio/video connection with compatible HDMI devices. Connect the Blu-ray disc player to **HDMI IN 1**.

To select this input, choose **HDMI 1** or **HDMI 2**.

### 9 DIGITAL IN1/2 (OPTICAL) jacks

To listen to optical digital audio, change the input to **Digital 1** or **Digital 2**.

### 10 AM LOOP antenna terminal

### 11 FM antenna socket

### 12 SUBWOOFER PREOUT jack (SX-LX08 model only)

Use the RCA plug cable furnished with the speaker system (or commercial alternative) to connect a powered subwoofer.

## Blu-ray disc player

### Front Panel

(Controls hidden behind the front panel door)

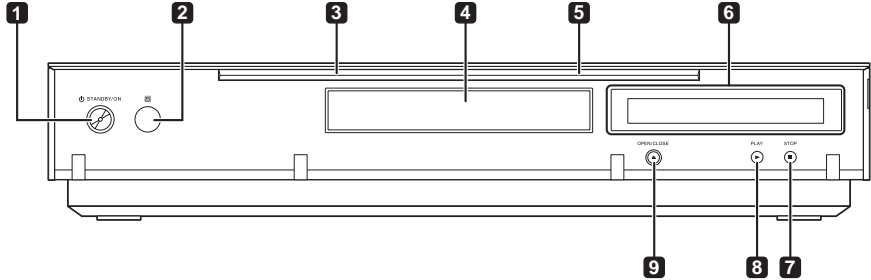

#### 1 STANDBY/ON

Press to turn the power on and off.

#### 2 Remote control sensor

Point the remote control to this, then operate it within approximately 7 m.

The player may have trouble capturing remote control signals if there is a fluorescent light nearby. If this happens, move the player away from the fluorescent light.

#### 3 HDMI indicator

This lights when an HDMI-compatible device is connected (page 76).

#### 4 Disc tray

#### 5 FL OFF indicator

This lights when **Off** is selected with **FL DIMMER**.

#### 6 Front panel display

#### 7 STOP

Press to stop playback.

#### 8 PLAY

Press to start playback.

#### 9 OPEN/CLOSE

Press to open and close the disc tray.

### Display

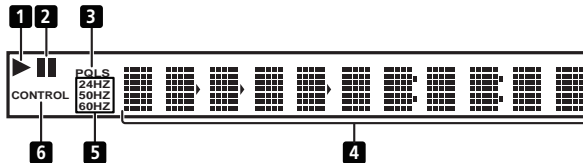

#### 1

Lights during playback.

#### 2

Lights when playback is paused.

#### 3 PQLS

Lights when the PQLS function is activated (page 78).

*Caution:* This system cannot use the PQLS function.

## 4 Character display

Displays the title/chapter/track number, elapsed time, etc.

## 5 24HZ/50HZ/60HZ

The frequency of the video frame or field being output lights.

## 6 CONTROL

Lights when the HDMI Control function is activated (page 78).

## Rear Panel

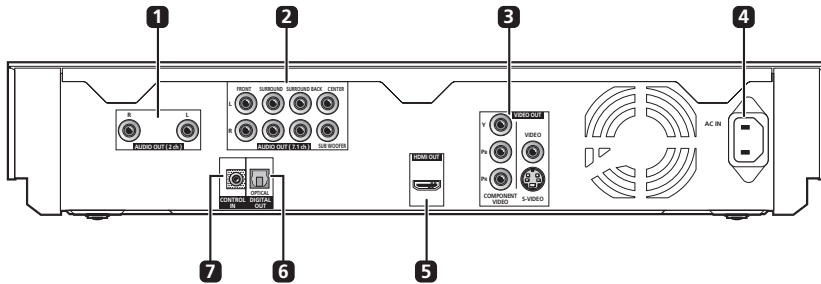

## 1 AUDIO OUT (2 ch) terminals

Connect with the audio input terminals on a TV or tape recorder, etc.

## 2 AUDIO OUT (7.1 ch) terminals

Connect with the 7.1 channel audio input terminals on an AV receiver or amplifier, etc.

## 3 VIDEO OUT terminals

**VIDEO** – Connect with the video input terminal on a TV.

**S-VIDEO** – Connect with the S-Video input terminal on a TV.

**COMPONENT VIDEO** – Connect with the component video input terminals on a TV.

## 4 AC IN

Connect the power cord here.

## 5 HDMI OUT terminal

Connect to the **HDMI IN 1** jack of the receiver with the supplied HDMI cable.

## 6 DIGITAL OUT (OPTICAL)

Connect with the digital audio input terminal on the other audio component.

## 7 CONTROL IN terminal

Use to control this player from the remote sensor of another Pioneer component with a **CONTROL OUT** terminal and bearing the  mark. Connect the **CONTROL OUT** of the other component to the **CONTROL IN** of this player using a mini-plug cord.

## Caution

- Be sure to connect cables for outputting the audio and video signals (pages 76 and 80).
- When connected via System Control, point the remote control toward the connected component. The remote will not work correctly when pointed at this player.
- You cannot use System Control with components that do not have a System Control terminal or with components manufactured by companies other than Pioneer.

## Chapter 2

# Speaker Setup Guide (LX03BD)

### Safety precautions when setting up

When assembling the speakers, lay them down flat on their side to avoid accidents or injury. Make sure to use a stable surface when assembling, setting up, and placing the speakers.

If the speakers are to be used in a stacked configuration, always use the provided brackets to secure them together (page 17).

### Home theater sound setup

Depending on the size and characteristics of your room, you can place your speakers in one of two ways using this system.

#### Standard surround setup

This is a standard multichannel surround sound speaker setup for optimal 5.1 channel home theater sound. The front left and right speakers should be about 1.8 m to 2.7 m apart.

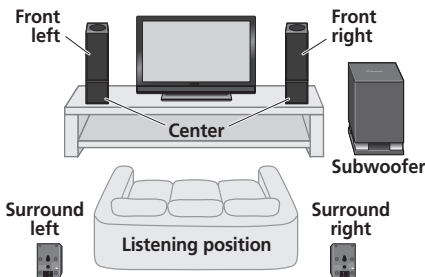

\*When center speakers are placed in the center.

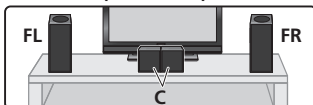

#### Front surround setup

This setup is ideal when rear surround speaker placement isn't possible or you want to avoid running long speaker cables in your listening area. The surround left and right speakers should be about 1.5 m apart.

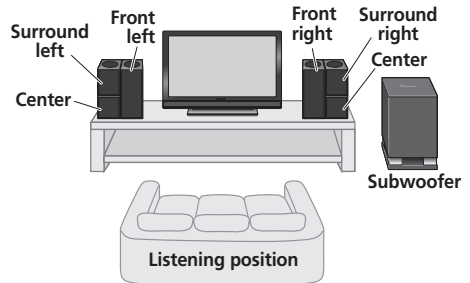

\*When center speakers are placed in the center.

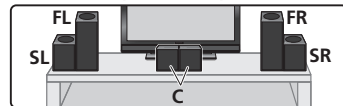



## Preparing the speakers

### 1 Attach the non-skid pads to the base of each speaker (as shown).

Use the adhesive side of the pads to attach them to the base (flat surface) of each speaker.

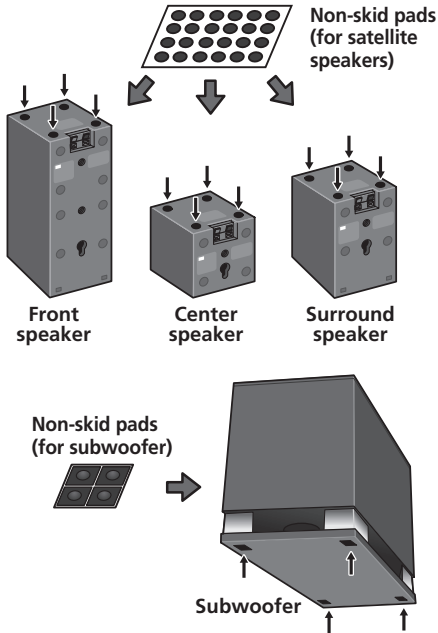

As shown in the illustration, stack the speakers. Align the brackets with the screw holes on the back of the two speakers, and use the two screws to fix in place.

*Standard surround setup:*

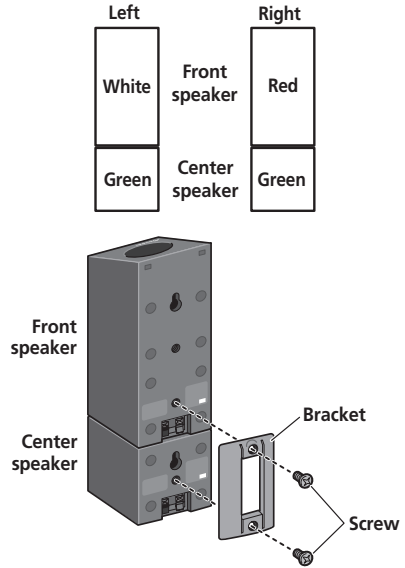

### 2 (When mounting center speakers to right and left) Stack the speakers and fix with the bracket.

Each speaker is provided with a color-coded indicator on the label on the rear side to assist identification. Refer to the color indicators and install the speakers correctly.

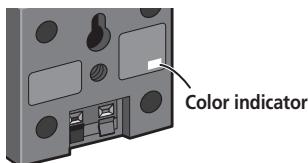

Front surround setup:

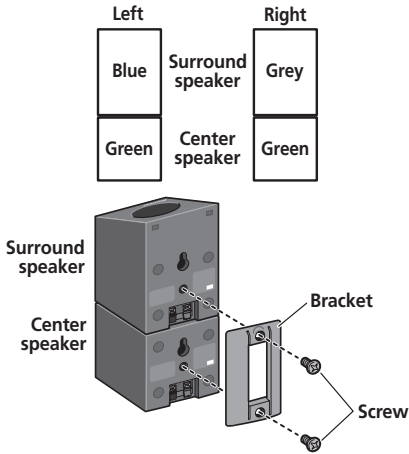

### Caution

- Do not attempt to carry the speakers when they are connected with the bracket. Doing so may cause damage to the bracket or worsen damage to the bracket and speakers in the event they are dropped.

### 3 Connect the speaker system.

Refer to *Connecting up* on page 26 to connect the speakers properly. After connecting everything, place the speakers as shown in the diagram above for optimal surround sound. After placing the speakers, run the Auto MCACC setup (page 29) to complete your surround sound setup.

### Using the supplied speaker stands

When setting up the front surround, the supplied accessory speaker stand can be used. Apply the non-skid pads (for speaker stand) to the four corners of the speaker stand and set the speakers on the stand.

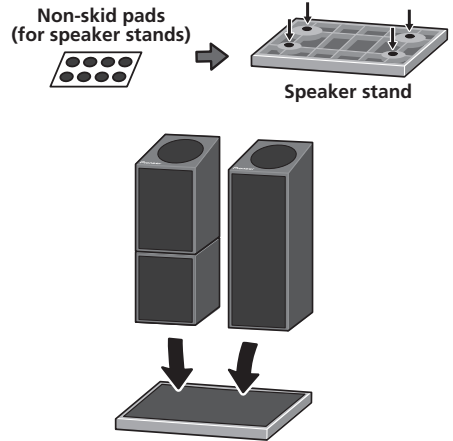

## Wall mounting the speakers

The front, center and surround speakers have a mounting hole which can be used to mount the speaker on the wall.

### Before mounting

- Remember that the speaker system is heavy and that its weight could cause the screws to work loose, or the wall material to fail to support it, resulting in the speaker falling. Make sure that the wall you intend to mount the speakers on is strong enough to support them. Do not mount on plywood or soft surface walls.
- Mounting screws are not supplied. Use screws suitable for the wall material and support the weight of the speaker.



### Caution

- If you are unsure of the qualities and strength of the wall, consult a professional for advice.
- Pioneer is not responsible for any accidents or damage that result from improper installation.

## Additional notes on speaker placement

- Install the main front left and right speakers at an equal distance from the TV.
- When using the Standard surround setup, install the surround speakers slightly above ear level for optimum effect.

### Precautions:

- When installing the center speaker on top of the TV, be sure to secure it with tape or some other suitable means. Otherwise, the speaker may fall from the TV due to external shocks such as earthquakes, endangering those nearby or damaging the speaker.
- The front, center and surround speakers supplied with this system are magnetically shielded. However, depending on the installation location, color distortion may occur if the speaker is installed extremely close to the screen of a television set. If this case happens, turn the power switch of the television set OFF, and turn it ON after 15 min. to 30 min. If the problem persists, place the speaker system away from the television set.
- The subwoofer is not magnetically shielded and so should not be placed near a TV or monitor. Magnetic storage media (such as floppy discs and tape or video cassettes) should also not be kept close to the subwoofer.
- Do not attach the subwoofer to the wall or ceiling. They may fall off and cause injury.

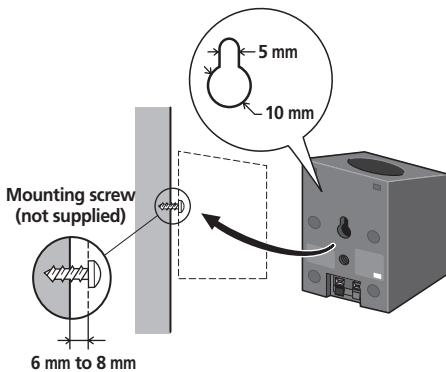

## Connect the speakers

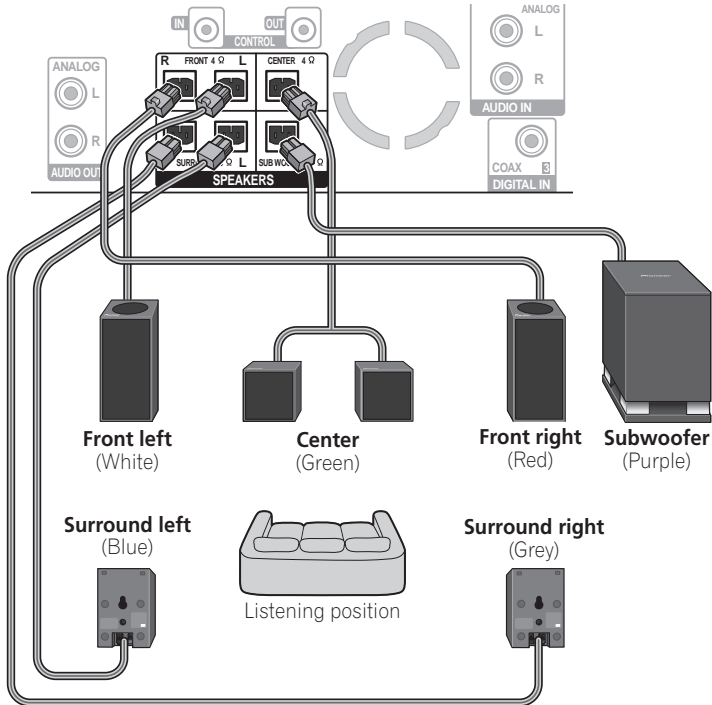

### Important

- When connecting this system or changing connections, be sure to switch power off and disconnect the power cord from the wall socket. After completing all connections, connect the power cords to the wall socket.



### WARNING

- Pioneer bears no responsibility for accidents resulting from faulty assembly or installation, insufficient mounting strength of walls, mounting fixtures (or other building fixtures), misuse or natural disasters.

- You may purchase and use your own speaker cables if desired. For details, see *Using your own speaker cables* on page 22.
- The front and surround speaker cables have a color-coded connector at one end and two bare wires at the other end.
- Two purple cables are provided for the subwoofer, one 4 meters and the other 10 meters in length. Use the appropriate cord depending on the length needed for the installation location.

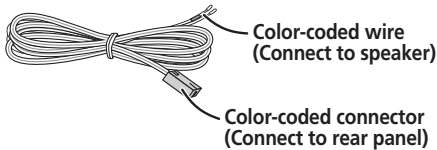

- Since there is only one terminal to connect the two center speakers, you will need to use the supplied Y-cable for the connection.
- Twist and pull off the protective shields on each wire.



- Connect the wires to the speaker. Each speaker in the illustration can be identified by means of the color-coded indicator provided on the rear-surface label. Match the color-coded wire with the color indicator on the label, then insert the color-coded wire into the red (+) side and the other wire into the black (-) side.

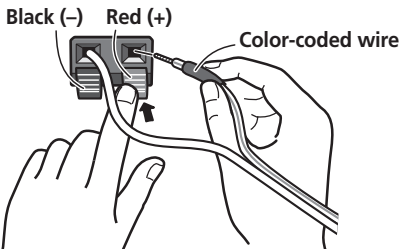

- When connecting the center speakers, connect the Y-cable dual end to the two center speakers in the same way.

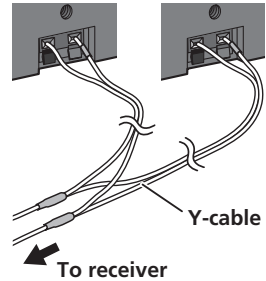

- Connect the other end to the color-coded speaker terminals on the rear of the receiver. Make sure to insert completely. The small lug at the wire-end of the speaker plug should face up or down depending on whether it's being plugged into one of the upper or lower speaker terminals. Please make sure to connect correctly.

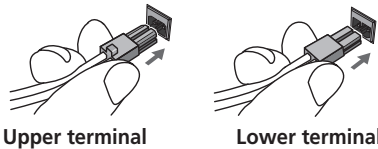

- Fasten the cables together with the spiral wrap. Hold multiple cables together and place the wrap over the cables from the end. Wrap the spiral wrap with the cables in the center. The spiral wrap may be cut at a desired length.

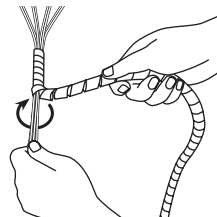



### Caution

- These speaker terminals carry **HAZARDOUS LIVE voltage**. To prevent the risk of electric shock when connecting or disconnecting the speaker cables, disconnect the power cord before touching any uninsulated parts.
- Do not connect any speakers other than those supplied to this system.
- Do not connect the supplied speakers to any amplifier other than the one supplied with this system. Connection to any other amplifier may result in malfunction or fire.
- After connecting the plugs, pull lightly on the cables to make sure that the ends of the cables are securely connected to the terminals. Poor connections can create noise and interruptions on the sound.
- If the cable's wires happen to be pushed out of the terminals, allowing the wires to come into contact with each other, it places an excessive additional load on the amp. This may cause the amp to stop functioning, and may even damage the amp.

### Using your own speaker cables

When connecting the speakers, you can purchase and use your own speaker cables if desired, in place of those furnished. In this case, perform the following procedures to attach the speaker cable adaptor to your own cables:<sup>1</sup>

- **While holding down the two buttons on the adaptor, insert the wire ends of your own cable into the adaptor.**

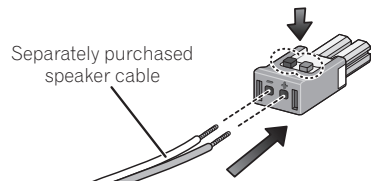

- White, Red, Blue, Grey and Purple speaker cable adaptors are provided as accessories. Use these to attach your own cables for the front left/right speakers, surround left/right speakers and subwoofer.
- Use the supplied Y- cable for center speakers connections.
- Confirm the +/– polarities of the two wires and the corresponding markings on the adaptor, and be sure to insert the proper wire core into the proper side.
- After inserting the wire cores, pull gently on the cable to confirm that the wires do not slip out.
- Be careful to prevent the cores of the two wires from touching each other, since a short circuit will result.

### Note

<sup>1</sup> Speaker cables can be of sizes between 0.3 sq and 1.0 sq (equivalent to 22 gauge and 17 gauge, respectively).

Chapter 2

# Speaker Setup Guide (SX-LX08)

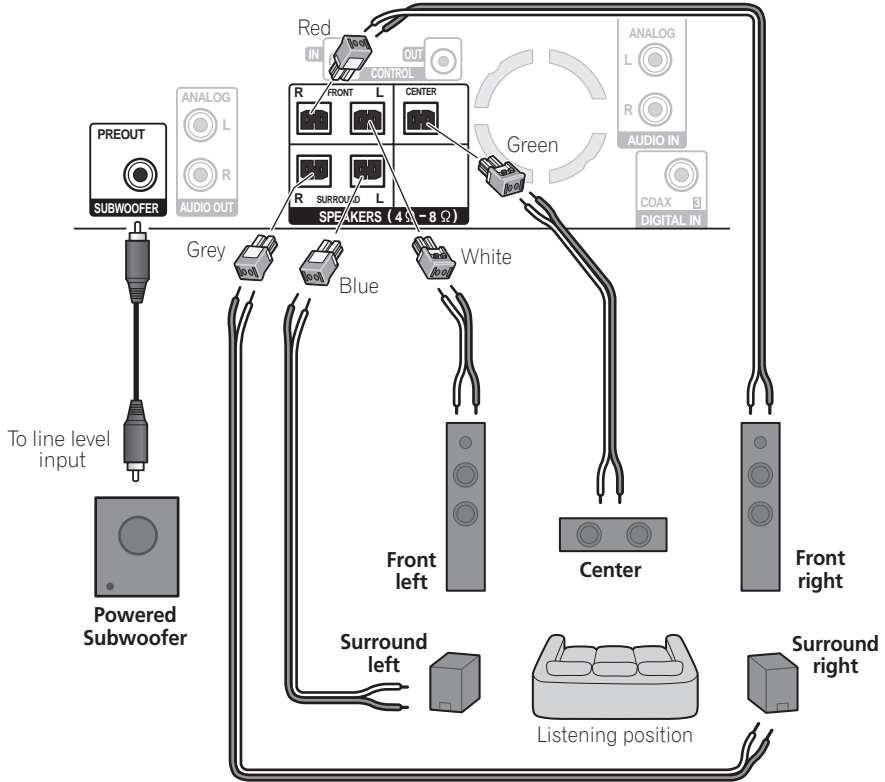

**Important**

- When connecting this system or changing connections, be sure to switch power off and disconnect the power cord from the wall socket. After completing all connections, connect the power cords to the wall socket.

**WARNING**

- Pioneer bears no responsibility for accidents resulting from faulty assembly or installation, insufficient mounting strength of walls, mounting fixtures (or other building fixtures), misuse or natural disasters.

## Safety precautions when setting up

When assembling the speakers, lay them down flat on their side to avoid accidents or injury. Make sure to use a stable surface when assembling, setting up, and placing the speakers.

## Home theater sound setup

This is a standard multichannel surround sound speaker setup for optimal 5.1 channel home theater sound. The front left and right speakers should be about 1.8 m to 2.7 m apart.

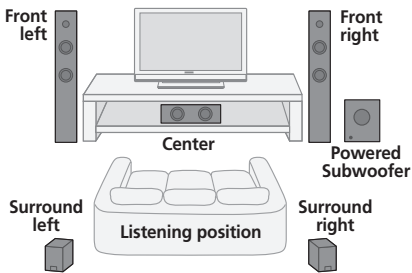

## Connect the speakers

Attach one end of the speaker cable provided with the speaker system (or a commercial alternative) to the speaker cable adaptor furnished as an accessory with this unit.

- When connecting the speakers, consult the operating instructions provided with the speaker system.
- This system is not provided with speaker cables. Please purchase speaker cables separately.

Twist exposed wire strands together.

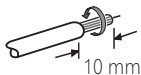

While holding down the two buttons on the adaptor, insert the wire ends of speaker cable into the adaptor.

- White, Red, Blue, Grey and Green speaker cable adaptors are provided as accessories. Use these to attach your own cables for the front left/right speakers, surround left/right speakers and center speaker.
- The speaker cable adaptors are color-coded to their matching speakers. Insert the proper cable into its adaptor of designated color. Confirm the polarity (+/-) indicated on the adaptor and cable, and match the polarities properly.

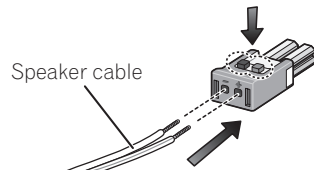

Connect the speaker cable adaptors to the color-coded speaker terminals on the rear of the receiver. Make sure to insert completely.

- The small lug at the wire-end of the speaker plug should face up or down depending on whether it's being plugged into one of the upper or lower speaker terminals. Please make sure to connect correctly.

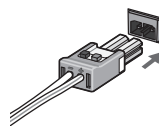

Upper terminal

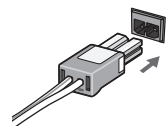

Lower terminal

Connect the other end to speaker terminals on the speaker system. Make sure to insert completely.

- Consult the operating instructions provided with the speaker and confirm the connection procedures.



Connect the subwoofer.

- Use the RCA plug cable furnished with the speaker system (or commercial alternative) to connect the **SUBWOOFER PREOUT** connector to the line level input connector of the powered subwoofer.



### Caution

- These speaker terminals carry **HAZARDOUS LIVE voltage**. To prevent the risk of electric shock when connecting or disconnecting the speaker cables, disconnect the power cord before touching any uninsulated parts.
- Do not connect any speakers other than those designated for this system.
- After connecting the plugs, pull lightly on the cables to make sure that the ends of the cables are securely connected to the terminals. Poor connections can create noise and interruptions on the sound.
- If the cable's wires happen to be pushed out of the terminals, allowing the wires to come into contact with each other, it places an excessive additional load on the amp. This may cause the amp to stop functioning, and may even damage the amp.

## Chapter 3

## Connecting up

## Basic connections

- The following describes connections to a TV equipped with HDMI and optical digital audio inputs.

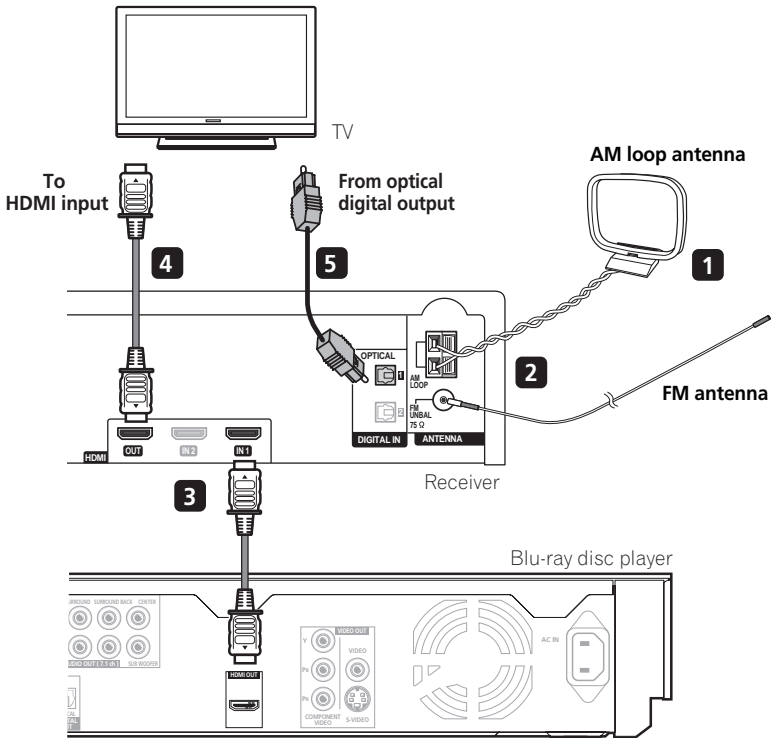
**Important**

- When connecting this system or changing connections, be sure to switch power off and disconnect the power cord from the wall socket. After completing all connections, connect the power cords to the wall socket.

**WARNING**

- Pioneer bears no responsibility for accidents resulting from faulty assembly or installation, insufficient mounting strength of walls, mounting fixtures (or other building fixtures), misuse or natural disasters.

## 1 Assemble the AM loop antenna.

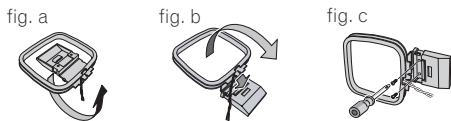

- a. Bend the stand in the direction indicated by the arrow.
- b. Clip the loop onto the stand.
- c. If you want to fix to a wall or other surface, perform step b after first securing the stand with screws.

It is recommended that you determine the reception strength before securing the stand with the screws.

## 2 Connect the AM and FM antennas<sup>1</sup>.

- a. Connect one wire of the AM loop antenna to each AM antenna terminal<sup>2</sup>.

For each terminal, press down on the tab to open; insert the wire, then release to secure.

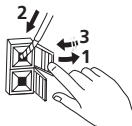

- b. Push the FM antenna<sup>3</sup> plug onto the center pin of the FM antenna socket.

## 3 Connect the Blu-ray disc player to the receiver.

Plug the HDMI cable into the **HDMI IN 1** jack on the rear of the receiver.

Plug the other end of the cable into the **HDMI OUT** jack on the rear of the Blu-ray disc player.

## 4 Connect the receiver to your TV.

Connect the **HDMI OUT** jack on receiver to an HDMI input on your TV.

- You can have audio from the receiver, as well as audio and video from the Blu-ray disc player, output to your TV by connecting with a single HDMI cable.

To connect to a TV with no HDMI input, see *Connecting to a TV with no HDMI input* on page 79.

## 5 Connect an audio cable from your TV to the receiver.

To listen to TV audio on this unit, connect the TV's audio output to **DIGITAL IN1 (OPTICAL)** on the receiver.<sup>4</sup>

Use a coaxial audio cable to connect to a TV with no optical digital audio input, see *Using this unit for TV audio* on page 46.

- To use the HDMI Control function when you are connected to a supported Pioneer Flat Screen TV, you must connect via HDMI.

You must first set '**TV Input**' to switch the input source of this unit to TV audio or to switch the audio from a Flat Screen TV with the HDMI Control function. For more information, see *Audio input settings from the TVs (TV Input)* on page 46.

### Note

- 1 • Keep antenna cables away from the receiver and other cables.
  - If reception with the supplied antenna is poor, see *Improving poor FM reception and Improving poor AM sound* on page 39 or *Connecting external antennas* on page 49.
  - Do not attach any antenna other than the provided loop antenna, or an external antenna as described on page 49.
- 2 • Don't let it come into contact with metal objects and avoid placing near computers, television sets or other electrical appliances.
  - If radio reception is poor, you may be able improve it by re-inserting each antenna wire into the opposite terminal.
  - For best reception, do not untwist the AM loop antenna wires or wrap them around the loop antenna.
- 3 To ensure optimum reception, make sure the FM antenna is fully extended and not coiled or hanging at the rear of the unit.
- 4 When digital connections are used, it may be necessary to adjust the digital audio output settings on the TV. For details, consult the operating instructions for your TV.

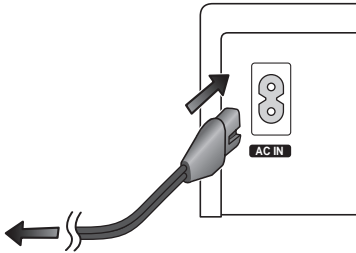
**6 Connect the power cords.<sup>1</sup>**

**To AC outlet**

- Connect each power cord to the AC inlet on the Blu-ray disc player and the receiver. Connect each power cord to a wall socket in the following order:
  1. Blu-ray disc player
  2. Receiver
  3. TV
- *SX-LX08 model only:* Connect the powered subwoofer's power cord in the same way.

**Note**

- Do not use any power cord other than the one supplied with this system.
  - Do not use the supplied power cord for any purpose other than connecting to this system.
  - After connecting this unit to an AC outlet, a 15-second initialization process begins. You cannot carry out any operations during initialization. The HDMI indicator on the display unit blinks during initialization, and you can turn this unit on once it has stopped blinking.

## Chapter 4

# Getting started

### Using the Auto MCACC setup for optimal surround sound

The Multichannel Acoustic Calibration (MCACC) system measures the acoustic characteristics of your listening area, taking into account ambient noise, and testing for channel delay and channel level. After you have set up the microphone provided, the system uses the information from a series of test tones to measure reverb, optimizing the speaker settings and equalization (Acoustic Calibration EQ) for your particular room.<sup>1</sup>



#### Important

- The test tones used for Auto MCACC setup are loud; however, do not turn the volume down during setup as this may result in a sub-optimal setup.
- Make sure the microphone and speakers are not moved during the MCACC setup.

#### 1 Connect the microphone to the MCACC jack on the front panel.

- Open the front panel door to access the MCACC jack.

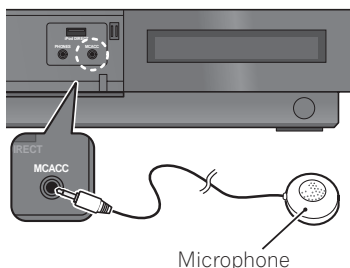

#### 2 Place the microphone at your normal listening position.

Place it about ear height, and make sure it is level by using a table or chair.

Make sure there are no obstacles between the speakers and the microphone.

RECEIVER



#### 3 If the system isn't already on, switch it on.

*SX-LX08 model only:* If using a subwoofer, be sure it is switched on and set to a comfortable listening level.



#### 4 Press MCACC.

Try to be as quiet as possible after pressing **MCACC**. The volume increases automatically and the system outputs a series of test tones.

- To cancel Auto MCACC setup before it has finished, press **MCACC**. The unit will continue to use the previous settings.

#### Note

<sup>1</sup> You only need to use the Auto MCACC setup once (unless you change the placement of your speakers or your room layout).

- If the ambient noise level is too high, **Noisy!** blinks in the display for five seconds. To exit and check the noise levels<sup>1</sup>, press **MCACC**, or to try again, press **ENTER** when **Retry** shows in the display.
- If you see an **Error MIC!** or **Error Speaker!** message in the display, there may be a problem with the microphone or the speaker connections. To try again, press **ENTER**<sup>2</sup>.
- *SX-LX08 model only:* If the display shows the '**Error SW!**' message, the unit was unable to detect output from the subwoofer. Check and confirm that the subwoofer's power switch is turned on, and set the volume to a comfortable listening level, then press **ENTER** once again.

When the MCACC setup is complete, the volume level returns to normal, **Complete**<sup>3</sup> shows in the display, and Acoustic Calibration EQ is activated.<sup>4</sup>

- Be sure to disconnect the microphone from this unit upon completion of the Auto MCACC setup.

#### Note

- 1 • If the room environment is not optimal for the Auto MCACC setup (too much ambient noise, echo off the walls, obstacles blocking the speakers from the microphone) the final settings may be incorrect. Check for household appliances (air conditioner, fridge, fan, etc.), that may be affecting the environment and switch them off if necessary.
  - Some older TVs may interfere with the operation of the microphone. If this seems to be happening, switch off the TV during Auto MCACC setup.
- 2 If this doesn't work, press **MCACC**, turn off the power, and check the problem indicated by the **Error** message, then try the Auto MCACC setup again.
- 3 If **Complete** doesn't appear, it is likely an error occurred during the setup. Please check all connections and try again.
- 4 See *Listening with Acoustic Calibration EQ* on page 34 to switch on/off Acoustic Calibration EQ.

## Chapter 5

## Listening to your system

**Important**

- This unit's audio function may be restricted depending on the sound source, Line Output setting (page 48), and HDMI audio setting (page 51). In this event, the menus may not appear, or a message may be displayed instead (page 62).

**Auto listening mode**

The Auto listening mode is the simplest way to listen to any source as it was mastered: the output from the speakers mirrors the channels in the source material.

- *LX03BD model only:* If you set up the system for Front surround (page 16), the Front Stage Surround modes will give the best results (page 33).

SURROUND

-  **Press to select the Auto listening mode.<sup>1</sup>**

- When playing stereo sources, the **STEREO** indicator will light. The **DOLBY SURROUND** indicator will light when playing a Dolby Surround sound source.

**Listening in surround sound**

You can listen to stereo or multichannel sources in surround sound. Surround sound is generated from stereo sources using one of the Dolby Pro Logic decoding modes.

- *LX03BD model only:* If you set up the system for Front surround (page 16), the Front Stage Surround modes will give the best results (page 33).

SURROUND

-  **Press repeatedly to select a listening mode.<sup>1</sup>**

The choices that appear in the display will vary according to the type of source that's playing.

*With two channel sources,* you can select from:

- **Auto** – See *Auto listening mode* above
- **DOLBY PL II MOVIE** (Dolby Pro Logic II Movie)<sup>2</sup> – 5.1 channel surround sound, especially suited to movie sources
- **DOLBY PL II MUSIC** (Dolby Pro Logic II Music)<sup>2</sup> – 5.1 channel surround sound, especially suited to music sources; see *Dolby Pro Logic II Music settings* below
- **DOLBY PRO LOGIC** (Dolby Pro Logic)<sup>2</sup> – 4.1 channel surround sound for use with any two-channel source
- **Stereo** – See *Listening in stereo* on page 33
- **A.L.C.** – See *Listening in stereo* on page 33

*With multichannel sources,* you can select (according to format):

- **Auto** – See *Auto listening mode* above
- **Stereo** – See *Listening in stereo* on page 33
- **A.L.C.** – See *Listening in stereo* on page 33

**Note**

- 1 • If the source is Dolby Digital or DTS, the corresponding indicator lights in the front panel display.
  - During 88.2 kHz/96 kHz source playback, the listening mode is fixed to **Auto** and cannot be changed.
- 2 The **DOLBY PL II** indicator will light.

## Dolby Pro Logic II Music settings

When listening in Dolby Pro Logic II Music mode (see above), there are three settings you can adjust: Center Width, Dimension, and Panorama.



1 Press when Dolby Pro Logic II Music mode is active.



2 Select 'Center Width', 'Dimension' or 'Panorama' then press ENTER.

- **Center Width** – Provides a better blend of the front speakers by spreading the center channel between the front right and left speakers, making it sound wider (higher settings) or narrower (lower settings).
- **Dimension** – Adjusts the depth of the surround sound balance from front to back, making the sound more distant (minus settings), or more forward (positive settings).
- **Panorama** – Extends the front stereo image to include the surround speakers for a 'wraparound' effect.



3 Adjust the setting, then press ENTER to confirm.

## Using Advanced Surround

The Advanced Surround effects can be used with any multichannel or stereo source for a variety of additional surround sound effects. These modes are designed to provide optimum listening effect when using the Standard surround setup described on page 16, 23.

ADV SURR

•  Press to select an Advanced Surround mode.

The **ADV SURR** indicator lights when one of these modes is chosen. You cannot switch between modes for some audio streams.<sup>1</sup>

Press repeatedly to select:

- **Action** – Designed for action movies with dynamic soundtracks
- **Unplugged** – Suitable for acoustic music sources
- **Expanded** – Creates an extra wide stereo field.
- **TV Surround** – Provides surround sound for both mono and stereo TV sources.
- **Sports** – Suitable for sports programs
- **Advanced Game** – Suitable for video games
- **Virtual** – The virtual surround effect is heard only from the front speakers, and from the subwoofer.
- **Ext Stereo** – Gives multichannel sound to a stereo source, using all of your speakers.

### Note

- During 88.2 kHz/96 kHz source playback, the listening mode is fixed to **Auto** and cannot be changed.
- When using a Pioneer Flat Screen TV with HDMI Control function support, these operating modes can be changed by operating the TV.



## Using Front Stage Surround Advance

(LX03BD model only)

The Front Stage Surround Advance modes are effective when you are using the Front surround setup as described on page 16.

-  **Press to select a Front Stage Surround Advance mode.**

The **F.S.SURR** indicator lights. You cannot switch between modes for some audio streams.<sup>1</sup>

Press repeatedly to select:

- **F.S.S.Focus5.1** – Use to provide a rich surround sound effect directed to the center area where the left and right speakers sound projection converges.
- **F.S.S.Wide5.1** – Use to provide a surround sound effect to a wider area than **F.S.S.Focus5.1** mode.
- **Extra Power** – Outputs stereo sound (in the case of multichannel sources, down-mixed stereo sound) from the surround speakers for powerful stereo effect.

## Listening in stereo

You can listen to any source — stereo or multichannel — in stereo. When playing a multichannel source, all channels are downmixed to the front left/right speakers and the subwoofer.

In the Auto level control stereo mode (A.L.C.), this unit equalizes playback sound levels if each sound level varies with the music source recorded in a portable audio player.

-  **Press repeatedly to select Stereo or A.L.C. mode.**

- **Stereo** – The **STEREO** indicator will light and ordinary stereo sound will be produced.
- **A.L.C.** – Listening in Auto level control stereo mode. The **STEREO** and **ALC** indicators will light.

## Listening with headphones

When headphones are connected, only the **Stereo**, **A.L.C.** and **PhonesSurround** modes are available.

- **With headphones connected, press SURROUND to select Stereo or A.L.C., or press ADV SURR to select PhonesSurround.**
  - **Stereo** – See *Listening in stereo* above
  - **A.L.C.** – See *Listening in stereo* above
  - **PhonesSurround** – Virtual surround sound for headphones.

## Using the Sound Retriever

When audio data is removed during the MP3 or WMA compression process, sound quality often suffers from an uneven sound image. The Sound Retriever feature employs new DSP technology that helps bring CD quality sound back to compressed two channel audio by restoring sound pressure and smoothing jagged artifacts left over after compression.

-  **Press while listening to a stereo source.**<sup>1</sup>

Press repeatedly to switch between:

- **Retriever On** — Switches the Sound Retriever on. The **S.RTRV** indicator lights.
- **Retriever Off** — Switches the Sound Retriever off.

### Note

<sup>1</sup> This setting cannot be used with multichannel or 88.2 kHz/96 kHz sources.

## Listening with Acoustic Calibration EQ

You can listen to sources using the Acoustic Calibration Equalization set in *Using the Auto MCACC setup for optimal surround sound* on page 29.<sup>1</sup>



1 Press to open the sound menu.



2 Select 'MCACC EQ' then press ENTER.



3 Switch 'EQ On' or 'EQ Off' then press ENTER to confirm.

- The **MCACC** indicator lights when Acoustic Calibration EQ is active.
- On the **EQ Off** setting, equalization is set to off and speaker settings (channel delay and channel level) remains as it is set.
- **EQ On** is selected automatically after the Auto MCACC setup is completed.

## Enhancing dialogue

The Dialogue Enhancement feature is designed to make the dialogue stand out from other background sounds in a TV or movie soundtrack.



1 Press to open the sound menu.



2 Select 'Dialogue' then press ENTER.



3 Select the amount of Dialogue Enhancement then press ENTER to confirm. Select between **Off**, **Mid**, **Max** or **Auto**.

- When Dialogue is set to **Auto**, the amount of Enhancement is selected automatically to optimally match the audio signal.
- The **DIALOG** indicator lights when Dialogue Enhancement is active.

## Using Midnight and Quiet listening modes

The Midnight listening feature allows you to hear effective surround sound of movies at low volume levels.

The Quiet listening feature reduces excessive bass or treble in a sound source.



1 Press to open the sound menu.



2 Select 'Tone' then press ENTER.



3 Select 'Midnight' or 'Quiet' then press ENTER to confirm.





- The **TONE** indicator lights.
- To cancel the Midnight or Quiet listening modes, select **Bass/Treble**.

### Note

<sup>1</sup> Acoustic Calibration EQ is not available when headphones are connected.



## Adjusting the bass and treble

Use the bass and treble controls to adjust the overall tone.

- 1  Press to open the sound menu.
- 2  Select 'Tone' then press ENTER.
- 3  Select 'Bass/Treble' then press ENTER.
  - Selecting **Bass/Treble** cancels the **Midnight** and **Quiet** listening modes. These modes cannot be used at the same time.
- 4  Use **←/→** to select 'Bass' or 'Treble'; use **↑/↓** to adjust the sound then press ENTER to confirm.
  - Bass and Treble can be adjusted from **-6dB** to **+6dB**.
  - When the Bass or Treble is set to something other than **0dB**, the **TONE** indicator lights.

## Boosting the bass level

There are two bass modes you can use to enhance the bass in a source.<sup>1</sup>



- 1  Press to open the sound menu.
- 2  Select 'Bass Mode' then press ENTER.

- 3  Select the desired **Bass Mode** setting, then press ENTER to confirm. Select between **Off**, **Music**, **Cinema** or **Auto**.
  - When Bass Mode is set to **Auto**, the setting (**Music** or **Cinema**) is selected automatically to optimally match the audio signal.
  - The **BASS MODE** indicator lights when Bass Mode is active.

## Adjusting sound delay

Some monitors have a slight delay when showing video, so the soundtrack will be slightly out of sync with the picture. By adding a bit of delay, you can adjust the sound to match the presentation of the video.

There are a total of 60 steps (levels) that you can adjust, with a total range of 200 msec.

- 1  Press to open the sound menu.
- 2  Select 'Sound Delay' then press ENTER.
- 3  Select the length of the delay in sound, then press ENTER to confirm.
  - This option is deactivated and not displayed if you have **Auto Delay** set to **On** in **HDMI Setup** (see *Setting the Auto Delay* on page 51).

 **Note**

<sup>1</sup> The Bass Mode is not available when headphones are connected.

## Chapter 6

## Connecting an iPod

## Connecting your iPod to this unit

This unit has a dedicated iPod terminal that will allow you to control playback of audio content from your iPod using the controls of this unit.<sup>1</sup>

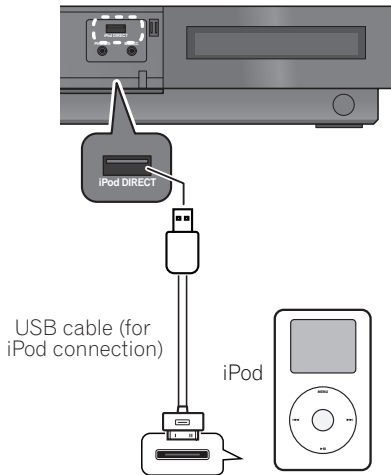

**1 Set this unit to the standby mode, and then use the USB cable (for iPod connection)<sup>2</sup> to connect your iPod to the iPod DIRECT terminal on the front panel of this unit.**

For the cable connection, refer to also the operating instructions for iPod.

**2 Switch the unit on and press the iPod input source button on the remote control to switch the unit to the iPod.**

The front panel display shows **Loading** while the unit verifies the connection and retrieves data from the iPod.

**3**  **Press to display iPod Top menu.**

When the display shows **Top Menu** you're ready to play music from the iPod.<sup>3</sup>

- If after pressing **iPod** the display shows **No Device**, try switching off the unit and reconnecting the iPod to the unit.

**iPod playback**

This unit's front panel display can be used to navigate tracks on your iPod.<sup>4</sup>

**Note**

- This unit is compatible with the audio of iPod nano, iPod fifth generation, iPod classic, iPod touch (not supported iPod shuffle and iPhone). However, that some of the functions may be restricted for some models. Note, however, compatibility may vary depending on the software version of your iPod. Please be sure to use the latest available software version.
  - iPod is licensed for reproduction of non-copyrighted materials or materials the user is legally permitted to reproduce.
  - Features such as the equalizer cannot be controlled using this unit, and we recommend switching the equalizer off before connecting.
  - Pioneer cannot under any circumstances accept responsibility for any direct or indirect loss arising from any inconvenience or loss of recorded material resulting from the iPod failure.
- The USB cable (for iPod connection) is not included with this unit.
- The controls of your iPod will be inoperable when connected to this unit. Features such as the equalizer cannot be controlled using this unit, and we recommend switching the equalizer off before connecting.
- Note that non-roman characters in the title are displayed as **#**.
  - This feature is not available for photos or video clips on your iPod.

## Finding what you want to play

When your iPod is connected to this unit, you can browse songs stored on your iPod by playlist, artist, album name, song name, genre or composer, similar to using your iPod directly.

- 

**Select a category, then press ENTER to browse that category.**

  - To return to the previous level any time, press **RETURN**.

- 

**Browse the selected category (e.g., albums).**

  - Use **←/→** to move to previous/next levels.

- Continue browsing until you arrive at what you want to play, then press ► to start playback.<sup>1</sup>**

Navigation through categories on your iPod looks like this:











- Playlists → Songs
- Artists → Albums → Songs
- Albums → Songs
- Songs
- Podcasts
- Genres → Artists → Albums → Songs
- Composers → Albums → Songs
- Audiobooks
- Shuffle Songs

### Tip

- You can play all of the songs in a particular category by selecting the **All** item at the top of each category list. For example, you can play all the songs by a particular artist.

## Basic playback controls

The following table shows the basic playback controls for your iPod. Press **iPod** to switch the remote control to the iPod operation mode.

Button	What it does
	Press to start playback. If you start playback when something other than a song is selected, all the songs that fall into that category will play.
	Pauses playback, or restarts playback when paused.
	Press and hold during playback to start scanning.
	Press to skip to previous/next track.
	Press repeatedly to switch between <b>Repeat One</b> , <b>Repeat All</b> and <b>Repeat Off</b> .
	Press repeatedly to switch between <b>Shuffle Songs</b> , <b>Shuffle Albums</b> and <b>Shuffle Off</b> .
	Press repeatedly to change the song playback information displayed in the front panel display.
	When browsing, press to move to previous/next levels. During playback, press to skip to previous/next track.
	During Audiobook playback, press to switch the playback speed: Faster ↔ Normal ↔ Slower
	Press to return to the <b>iPod Top</b> menu screen.
	Press to return to the previous level.

### Note

<sup>1</sup> If you're in the song category, you can also press **ENTER** to start playback.



### Important



If an error message lights in the front panel display, try following the points below:

#### Symptom What it means

<b>Error I1</b>	There is a problem with the signal path from the iPod to the unit. Switch off the unit and reconnect the iPod to the unit. If this doesn't seem to work, try resetting your iPod.
<b>Error I2</b>	The software version being used with the iPod needs to be updated. Update the software being used with the iPod (please use the latest iPod software versions later than the iPod updater 2004-10-20).
<b>Error I3</b>	The iPod that is not supported is connected. Check whether the iPod was supported by this unit (page 36).  When the iPod software version is too old, update the iPod software to the latest version.
<b>Error I4</b>	When there is no response from the iPod, update the iPod software to the latest version. If this doesn't seem to work, try resetting your iPod.
<b>iPod Error</b>	The power requirements of the iPod are too high for this unit.
<b>No Music Track</b>	There are no playable songs currently stored in the iPod. Input some music files compatible with iPod playback.
<b>No Track</b>	When there are no tracks in the category selected on the iPod. Select a different category.

### Switching the iPod controls<sup>1</sup>

You can switch over the iPod controls between the iPod and the unit.

-  **Press to switch the iPod controls.<sup>2</sup>**  
This will enable the controls and display on your iPod; simultaneously, this unit's remote control unit will be disabled.
-  **Press again to switch back to the receiver controls.**

*iPod is a trademark of Apple Inc., registered in the U.S. and other countries.*

#### Note

- You cannot use this function, when an iPod of fifth generation or iPod nano of first generation is connected.
- When this function is set, iPod images cannot be played on this unit.

## Chapter 7

# Listening to the radio

### Listening to the radio

The tuner can receive both FM and AM broadcasts, and lets you memorize your favorite stations so you don't have to manually tune in every time you want to listen.





- 1**  **Switch to the tuner, then press repeatedly to select the FM or AM band.**  
The display shows the band and frequency.

- 2**  **Tune to a frequency.**  
There are three tuning modes — manual, auto, and high-speed:

- **Manual tuning** – Press **TUNE +/-** repeatedly to change the displayed frequency.
- **Auto tuning** – Press and hold **TUNE +/-** until the frequency display starts to move, then release. The tuner will stop on the next station it finds. Repeat to keep searching.
- **High-speed tuning** – Press and hold **TUNE +/-** until the frequency display starts to move rapidly. Keep the button held down until you reach the frequency you want. If necessary, fine tune the frequency using the manual tuning method.

### Improving poor FM reception

If you're listening to an FM station in stereo but the reception is weak, you can improve the sound quality by switching to mono.

- 1**  **Press after tuning to an FM radio station.**
- 2**  **Select 'Tuner Setup' then press ENTER.**
- 3**  **Choose 'FM Auto/Mono' then press ENTER.**
- 4**  **Select 'FM Mono' then press ENTER.**

The mono indicator (○) lights when the tuner is in mono reception mode.

Select **FM Auto** above to switch back to auto-stereo mode (the stereo indicator (⊕) lights when receiving a stereo broadcast).

### Improving poor AM sound

The simplest way to improve the sound quality of AM radio is to make sure that the TV in the room is switched off. Also try changing the position and direction of the AM loop antenna.

## Changing the noise cut mode

If you find that the AM sound quality is bad even after trying the above, you may be able to improve it using a different noise cut mode. Just choose the one that sounds best.

-  **1 Press after tuning to an AM radio station.**

-  **2 Select 'Tuner Setup' then press ENTER.**

-  **3 Choose 'Noise Cut' then press ENTER.**

-  **4 Select a Noise cut mode (1, 2 or 3) then press ENTER.**

## Memorizing stations

This system can memorize up to 30 stations, stored in three banks, or classes (A, B and C) of 10 stations each.

### 1 Tune to an FM or AM radio station.

Select mono or auto-stereo reception (FM) or the Noise Cut mode (AM) as necessary. These settings are saved along with the preset.

-  **2 Press T.EDIT.**

-  **3 Press to select one of the three classes, then press ST +/- to select the station preset you want.**

You can also use the number buttons to select a preset.

-  **4 Press ENTER.**

After pressing **ENTER**, the preset class and number stop blinking and the system memorize station.

## Listening to station presets

You will need to have some presets stored to do this.

-  **1 Press to select the class in which the channel is stored.**

Press repeatedly to cycle through classes A, B and C.

-  **2 Select the station preset you want.**

- You can also use the number buttons on the remote control to recall the station preset.



## Using RDS

Radio Data System (RDS) is a system used by most FM radio stations to provide listeners with various kinds of information — the name of the station and the kind of show they're broadcasting, for example.

One feature of RDS is that you can search by type of program. For example, you can search for a station that's broadcasting a show with the program type, **Jazz**.

You can search the following program types:<sup>1</sup>

- |  |  |
|--|--|
| <b>News</b> – News   | <b>Finance</b> – Stock market reports, commerce, trading, etc.                       |
| <b>Affairs</b> – Current Affairs   | <b>Children</b> – Programs for children  |
| <b>Info</b> – General Information  | <b>Social</b> – Social affairs   |
| <b>Sport</b> – Sport   | <b>Religion</b> – Programs concerning religion                                       |
| <b>Educate</b> – Educational   | <b>Phone In</b> – Public expressing their views by phone                             |
| <b>Drama</b> – Radio plays, etc.   | <b>Travel</b> – Holiday-type travel information as opposed to traffic announcements. |
| <b>Culture</b> – National or regional culture, theater, etc.                   | <b>Leisure</b> – Leisure interests and hobbies                                       |
| <b>Science</b> – Science and technology  | <b>Jazz</b> – Jazz   |
| <b>Varied</b> – Usually talk-based material, such as quiz shows or interviews. | <b>Country</b> – Country music   |
| <b>Pop M</b> – Pop music   | <b>Nation M</b> – Popular music in a language other than English                     |
| <b>Rock M</b> – Rock music   | <b>Oldies</b> – Popular music from the '50s and '60s                                 |
| <b>Easy M</b> – Easy listening   | <b>Folk M</b> – Folk music   |
| <b>Light M</b> – 'Light' classical music                                       | <b>Document</b> – Documentary  |
| <b>Classics</b> – 'Serious' classical music                                    |  |
| <b>Other M</b> – Music not fitting above categories                            |  |
| <b>Weather</b> – Weather reports and forecasts, meteorological information     |  |

## Displaying RDS information

Use **DISPLAY** to display the different types of RDS information available.<sup>2</sup>

-  **Press for RDS information.**

Each press changes the display as follows:

- **Radio Text (RT)** – Messages sent by the radio station. For example, a talk radio station may provide a phone number as RT.
- **Program Service Name (PS)** – The name of the radio station.
- **Program Type (PTY)** – This indicates the kind of program currently being broadcast.
- **PTY SEARCH** – PTY search (see below)
- Current tuner frequency

## Searching for RDS programs

You can search for a program type listed above.

- 1  **Press for the FM band.<sup>3</sup>**

- 2  **Press repeatedly until 'PTY SEARCH' appears in the display.**

- 3  **Select the program type you want to hear.**

- 4  **Start the search.**

The system searches the station presets for a match. If it finds one, searching stops for five sec.

- 5 **If you want to keep listening to the station, press ENTER within the five seconds.** If you don't press **ENTER**, searching resumes.

### Note

- 1 In addition, there are three other program types, **TEST**, **ALARM!**, and **None**, **ALARM!** and **TEST** are used for emergency announcements. **None** appears when a program type cannot be found.
- 2 • If any noise is picked up while displaying the RT scroll, some characters may be displayed incorrectly.
  - If you see **No Radio Text Data** in the RT display, it means no RT data is sent from the broadcast station. The display will automatically switch to the PS data display (if no PS data, the frequency is displayed).
  - In the PTY display, **NO DATA** or **None** may be shown. In this case, the PS display is shown after a few seconds.
- 3 RDS is only possible in the FM band.

## Chapter 8

# Surround sound settings



### Important

- This unit's audio function may be restricted depending on the Line Output setting (page 48) and HDMI audio setting (page 51). In this event, the menus may not appear.

## Using the Sound Setup menu

From the Sound Setup menu you can access all the surround sound settings of the system.

During setup, the speakers are represented by the following letters:

- **L** – Front left speaker
- **C** – Center speaker
- **R** – Front right speaker
- **SR** – Surround right speaker
- **SL** – Surround left speaker
- **SW** – Subwoofer

## Effective Sound (for optimum sound)

With the uniquely shaped high-quality speakers supplied with this unit, the Effective Sound mode enables the following Pioneer exclusive audio technologies designed to maximize the real experience of sound originally inherent in movies and music.

Turn on the Effective Sound mode under normal circumstances to maximize the capabilities of this unit.<sup>1</sup>

### • Dynamic Range Compression





Resuscitates detailed sound susceptible to ambient noise to create an acoustic environment where you feel as if you are right in the action.

### • Frequency Characteristic Correction

*(LX03BD model only)*

Realizes the playback characteristic optimized for long hours of listening in addition to the added features of the supplied speaker units.

The Effective Sound mode can be turned off (activating Direct Sound mode) by doing the following:

- 
**1 Press SETUP.**
- 
**2 Select 'Sound Setup', then press ENTER.**
- 
**3 Select 'Sound Field', then press ENTER.**
- 
**4 Select 'Direct Sound', then press ENTER to confirm.**

To return to Effective Sound mode, perform the same procedure noted above to select 'EffectiveSound'.

  - When Direct Sound is selected, the **DIRECT** indicator lights.

### Note

<sup>1</sup> The Sound Field setting is not available when headphones are connected.

## Channel level setting<sup>1</sup>

The Auto MCACC feature (see page 29) should give you the best surround sound setup. However you may find that by further adjustment of the channel levels you can improve the surround sound in your listening room.

This method of setting the channel levels allows you to listen to a source and adjust the levels of each playback channel.

The test tone method can also be used to adjust channel levels.<sup>2</sup>

**1**  **Open the 'Sound Setup' menu.**

**2**  **Select 'ChannelLevel', then press ENTER.**

**3**  **Use ←/→ to select a channel<sup>3</sup> or ↑/↓ to adjust the level of that channel.**

- You can adjust the level of each channel by ±10 dB.

**4**  **Press once when you're finished.**

- If you use the Auto MCACC feature again, it will overwrite the settings you have made here.

## Speaker distance setting

The Auto MCACC feature (see page 29) should give you the best surround sound setup. However you may find that by further adjustment of the speaker distance settings you can improve the surround sound in your listening room.

Set the distance of each speaker from your normal listening position.

**1**  **Open the 'Sound Setup' menu.**

**2**  **Select 'Distance', then press ENTER.**

**3**  **Use ←/→ to select a speaker or ↑/↓ to adjust the distance.**

Each speaker can be adjusted from 0.1m to 9.0m.

**4**  **Press ENTER when you're finished.**

- If you use the Auto MCACC feature again, it will overwrite the settings you have made here.

### Note

<sup>1</sup> The Channel level setting is not available when headphones are connected.





<sup>2</sup> No test tone is output when audio is muted.

<sup>3</sup> When **Test Tone** is selected, the test tone moves automatically from speaker to speaker in the order L→C→R→SR→SL→SW. Adjust the ↑/↓ controls so that the test tone is heard at the same volume from each speaker when sitting in the main listening position. However, the test tone from the subwoofer may sound lower than other tones, in which case adjust the level while listening to a source. Press **ENTER** when you're finished.

## Dynamic Range Control

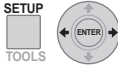

When watching Dolby Digital or DTS material at low volume, low level sounds — including some of the dialog — can be difficult to hear properly. Using one of the Dynamic Range Control (DRC) settings can help by bringing up the low level sounds, while controlling high level peaks.

Dynamic Range Control works only with Dolby Digital soundtracks and some DTS soundtracks.

- 1  **Open the 'Sound Setup' menu.**
- 2  **Select 'D.R.C.', then press ENTER.**
- 3  **Select a setting.**  
Select one of the following:
  - **D.R.C. High** – Dynamic range is reduced (loud sounds are reduced in volume while quieter sounds are increased)
  - **D.R.C. Mid** – Mid setting
  - **D.R.C. Off** – No dynamic range adjustment (use when listening at higher volume)
- 4  **Press to exit.**

## Dual mono setting

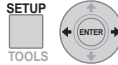
Specifies how dual mono encoded Dolby Digital soundtracks should be played. This setting can also be used to change the audio channels for DVD-RW discs recorded in bilingual audio, and external inputs with bilingual audio (HDMI and optical/coaxial digital inputs).

- 1  **Open the 'Sound Setup' menu.**
- 2  **Select 'Dual Mono', then press ENTER.**

- 3  **Select a setting.**  
Select one of the following:

- **CH1 Mono** – Only channel 1 is played
- **CH2 Mono** – Only channel 2 is played
- **CH1/CH2** – Both channels are played through the front speakers

## Virtual Surround Back

This mode allows you to use your surround speakers with standard surround setup to listen to a virtual surround back channel. You can choose to listen to sources with no surround back channel information, or if the material sounds better in the format (for example, 5.1) for which it was originally encoded, you can have the unit only apply this effect to 6.1 encoded sources like Dolby Digital EX or DTS-ES.<sup>1</sup>

- 1  **Open the 'Sound Setup' menu.**

### Note

- 1 • Depending on the input signal and the listening mode, the Virtual Surround Back mode may not be effective.
- The Virtual Surround Back mode is not effective when the headphones are connected or when using the Front surround setup.

2  Select 'Virtual SB', then press ENTER.

3  Select a setting.  
Select one of the following:

- **Vir.SB On** – Virtual Surround Back is always used (for example, on 5.1 encoded material).
- **Vir.SB Off** – Virtual Surround Back mode is switched off.



The **V.SB** indicator lights when Virtual Surround Back is active.

4  Press to exit.

## LFE Attenuate

Some Dolby Digital and DTS audio sources include ultra-low bass tones.

Set the LFE attenuator as necessary to prevent the ultra-low bass tones from distorting the sound from the speakers.

1   Open the 'Sound Setup' menu.

2  Select 'LFE ATT', then press ENTER.



3  Select a setting.  
Select one of the following:

- **0dB** – The LFE is not limited, which is the recommended value.
- **-10dB** – The LFE is limited by the respective degree.
- **LFE Off** – No sound is output from the LFE channel.

4  Press to exit.

## DTS CD setting

If you play a DTS-encoded CD, you will need to change this setting to hear the decoded signal.

1   Open the 'Sound Setup' menu.

2  Select 'CD Type', then press ENTER.

3  Select a setting.  
Select one of the following:

- **Normal CD** – Use for playback of regular audio CDs. Some DTS-encoded CDs will output noise when played.
- **DTS-CD** – Use for playback of DTS-encoded CDs, but note that the beginning of regular CD tracks may be skipped.

4  Press to exit.

## Chapter 9

## Other connections

**Important**

- When making or changing connections on the rear panel of this unit, be sure to switch power off and disconnect the power cord from the wall socket.  
After completing all connections, connect the power cord to the wall socket.

**Using this unit for TV audio**

To listen to audio from a TV, connect the TV's audio cable to one of the inputs on this unit.

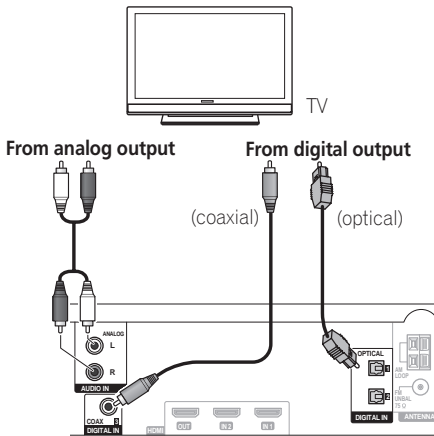





- Connect the audio output jacks on your TV to the audio input jacks on the receiver.
- You can connect by either a digital or analog audio cable. Select only one method to make connections.
- To use the HDMI Control function when you are connected to a supported Pioneer Flat Screen TV, you must connect via HDMI.

- When digital connections are used, it may be necessary to adjust the digital audio output settings on the TV. For details, consult the operating instructions for your TV.

**Audio input settings from the TVs (TV Input)**

To listen to audio from a Flat Screen TV on this device, you will need to connect an audio cable other than an HDMI cable. From this menu, set the audio input to that which you would like to connect. Press **TV** on the remote control to switch this unit to the input source selected here. This setting is changed to the selected input and the audio from the Flat Screen TV is output from this device.

Select from inputs **Digital 1 OPT**, **Digital 2 OPT**, **Digital 3 COAX** and **Analog**.

- 
  

**Press SETUP.**
- 
  
**Select 'System Setup' then press ENTER.**
- 
  
**Select 'TV Input', then press ENTER.**
- 
  
**Adjust the setting then press ENTER to confirm.**

## Listening to the sound of an external device on this receiver

You can connect both analog and digital external audio sources to this system.

- For a device with a video output, connect directly to the TV using a separate video cable, etc.

We recommend using an HDMI cable to connect sources that have HDMI terminals. For more information see *Connecting using HDMI* on page 50.

## Connecting for digital audio

This system has several digital inputs for digital playback components, such as your HDD/DVD recorder, digital satellite receiver or TV game.

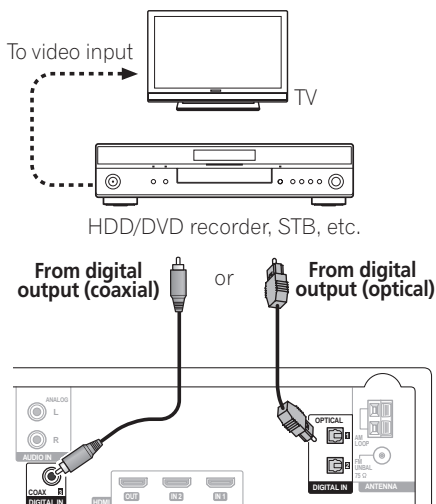

- **Connect the digital output jack on HDD/DVD recorder, etc. to one of the DIGITAL input jacks on this unit.**

Use a commercially available optical cable or coaxial cable to make this connection.

- When digital connections are used, it may be necessary to adjust the digital audio output settings on the connected component. For details, consult the operating instructions for the component involved.

## Connecting an analog audio component

You can use the **ANALOG AUDIO IN** jacks to connect an analog audio component, such as a VCR or tape player.

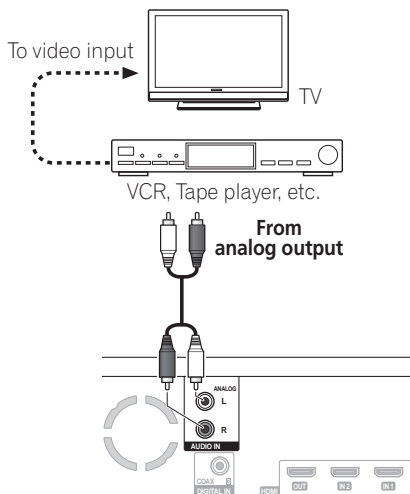

## Listening to an external audio source

To listen to audio from a connected external component on this system, choose its input function on the remote control. Some Pioneer products can be controlled via this remote.

### RECEIVER

- 1 If the system isn't already on, switch it on.

Also make sure that the external source (TV, HDD/DVD recorder, etc.) is switched on.

## 2 **LINE** Select an audio input source.

Input sources are cycled through as shown below:

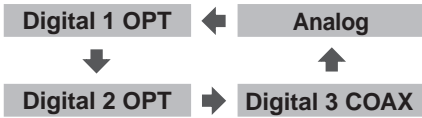

## 3 If necessary, start playback of the external source.



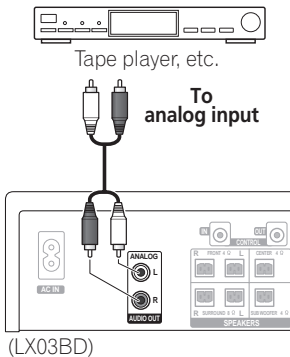

## Outputting the sound of this receiver to an external device

You can use the **ANALOG AUDIO OUT** jacks to connect an analog audio component, such as a tape player, and record the sound of the receiver's tuner, etc.



## Line Output setting

Use to select the audio down-mix method when outputting Dolby Digital multi-channel sound sources from the **ANALOG AUDIO OUT** jacks.<sup>1</sup>

-  **Press SETUP.**
-  **Select 'Sound Setup', then press ENTER.**
-  **Select 'Line Output', then press ENTER.**
-  **Select a setting.**  
 Select one of the following:
  - **Lo/Ro(Stereo)** – A simple stereo downmix (left-only/right-only, or Lo/Ro) is output (suitable for playback on a two-channel stereo system or on headphones).
  - **Lt/Rt** – A surround-compatible downmix (left-total/right-total, or Lt/Rt) of Dolby multichannel sources is output, (suitable for Dolby Surround Pro Logic or other matrix decoding). The **L.OUT** indicator lights.
-  **Press to exit.**

### Note

- When the Line Output is switched to **Lt/Rt**, the sound function will be fixed at the current setting and cannot be changed. The display will briefly flash **Line Out Mode** if an attempt is made to use a prohibited function.
  - When the Line Output is to **Lo/Ro(Stereo)**, the audio from the analog output jacks may be interrupted, depending on the operation.
  - When using DTS multi-channel sound sources, output is in **Lo/Ro(Stereo)**.



## Connecting external antennas

For an external AM antenna, use 5 to 6 meters of vinyl-insulated wire and set up either indoors or outdoors. Leave the loop antenna connected.

For an external FM antenna, use a PAL connector to hook up an external FM antenna.

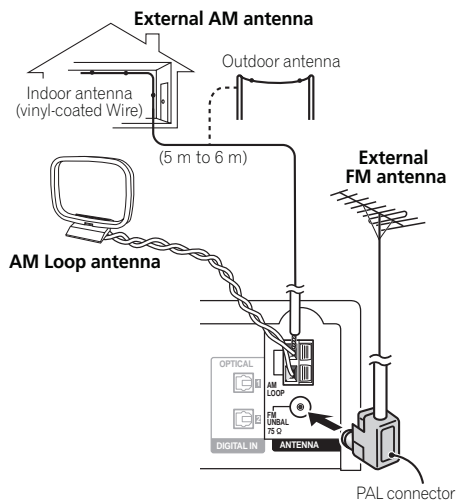

## About control out connections

Many Pioneer components support CONTROL connections, by which you can use the remote controls of any connected components by aiming them at the sensor of just one component.

When you use a remote control, the control signal is passed along the chain to the appropriate component.

If you choose to use this feature, you must make sure that you also have at least one set of HDMI or analog audio jacks connected to another component for grounding purposes.

- **Using a cable with a mono mini-plug on either end, connect the CONTROL IN jack on another Pioneer component to the CONTROL OUT jack on the rear panel.**

This will allow you to control the other component by pointing its remote at the front panel.

## Connecting using HDMI

If you have a HDMI or DVI (with HDCP) equipped monitor or display, you can connect it to this system using the supplied (or commercially available) for high quality digital video.<sup>1</sup>

See *About HDMI* on page 52 for more about the HDMI connection.

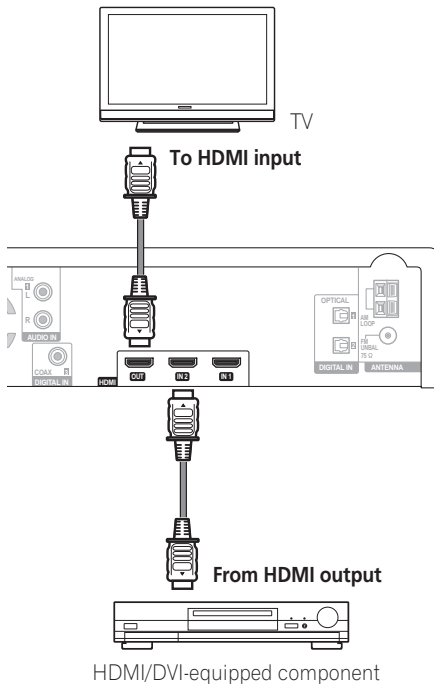

**1 Use the supplied HDMI cable to connect the HDMI IN 1/2 interconnect on this system to an HDMI output on your HDMI component.**

- With the arrow on the cable plug facing up, connect the plug to the player's connector.

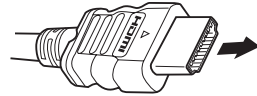

Once this system is properly connected to your HDMI component, the **HDMI** indicator (red) lights up on the front panel when you watch HDMI contents.

**2 Use the supplied HDMI cable to connect the HDMI OUT interconnect on this system to an HDMI interconnect on an HDMI-compatible display.**

**3 <sup>1/2</sup> HDMI Press repeatedly to select the HDMI input you've connected to (for example, HDMI 2).**

You can also use the front panel **INPUT** to carry out this operation.





- Set the HDMI Audio setting to **TV** in *Switching the HDMI audio setting* below if you want to hear HDMI audio output from your TV or Flat Screen TV (no sound will be heard from this unit).
- If the video signal does not appear on your TV or Flat Screen TV, try adjusting the resolution settings on your component or display.

### Note

- An HDMI connection can only be made with DVI-equipped components compatible with both DVI and High Bandwidth Digital Content Protection (HDCP). If you choose to connect to a DVI connector, you will need a separate adaptor (DVI → HDMI) to do so. A DVI connection, however, does not support audio signals. Consult your local audio dealer for more information.
- This system has been designed to be compliant with HDMI (High-Definition Multimedia Interface).
- When HDMI Audio is set to **TV**, sound is output from this unit to the TV connected to the HDMI connectors in for audio format supported by that TV.
- Depending on the component you have connected, using a DVI connection may result in unreliable signal transfers.





### Switching the HDMI audio setting

Specifies the routing of the HDMI audio signal out of this system (amp) or through to a TV or Flat Screen TV. You cannot use a number of sound functions of this system when HDMI audio is set to **TV**.

- 1  Press **SETUP**.
- 2  Select 'HDMI Setup' then press **ENTER**.
- 3  Select 'HDMI Audio', then press **ENTER**.
- 4  Adjust the setting then press **ENTER** to confirm.
  - **AMP** – Output an HDMI audio signal from this system.
  - **TV** – Output an HDMI audio signal from a TV or Flat Screen TV.<sup>1</sup>

### Setting the Auto Delay

This feature automatically corrects the audio-to-video delay between components connected with an HDMI cable. The audio delay time is set depending on the operational status of the display connected with an HDMI cable. The audio delay time is automatically adjusted according to the video delay time.

- 1  Press **SETUP**.
- 2  Select 'HDMI Setup' then press **ENTER**.
- 3  Select 'Auto Delay', then press **ENTER**.
- 4  Select 'A.Delay On' or 'A.Delay Off' then press **ENTER** to confirm.



#### Tip





- This feature is only available when the connected display supports the automatic audio/video synchronizing capability ('lip-sync') for HDMI or HDMI Control. If you find the automatically set delay time unsuitable, set **A.Delay** to **Off** and adjust the sound delay settings manually (page 35).

#### Note

<sup>1</sup> This makes it possible to use the TV's built-in speakers to listen to the audio input from an **HDMI 1/2** component. In this event, no sound will be heard from this unit's speakers (or headphones). All other audio sources (including **TUNER**) are output from this unit normally.

## Resetting the HDMI connection

If the screen goes blank (for example, after changing the resolution), check the troubleshooting guide on (page 62). If this doesn't solve the problem, follow the steps below to reset the HDMI connection.

- 1  Press **SETUP**.
- 2  Select 'Initialize' then press **ENTER**.
- 3  Select 'HDMI Init' then press **ENTER**.
  - **Initialize OK?** is displayed.
- 4  Press **ENTER** to confirm initialization.

The system will restart and the HDMI settings are automatically reset to the factory defaults.

## About HDMI

HDMI (High-Definition Multimedia Interface) supports both video and audio on a single digital connection for use with DVD players, DTV, set-top boxes, and other AV devices. HDMI was developed to provide the technologies of High-bandwidth Digital Content Protection (HDCP) as well as Digital Visual Interface (DVI) in one specification. HDCP is used to protect digital content transmitted and received by DVI-compliant displays.

HDMI has the capability to support standard, enhanced, or high-definition video plus standard to multichannel surround-sound audio. HDMI features include uncompressed digital video, a bandwidth of up to 2.2 gigabytes per second (with HDTV signals), one connector (instead of several cables and connectors), and communication between the AV source and AV devices such as DTVs.

*HDMI, the HDMI logo and High-Definition Multimedia Interface are trademarks or registered trademarks of HDMI Licensing LLC.*

## Chapter 10

# HDMI Control

### Important

- The KURO LINK function name used on the web and in catalogues is referred to as HDMI Control in the operating instructions and on the product.

By connecting this unit to an HDMI Control-compatible Pioneer Flat Screen TV or the Blu-ray disc player with an HDMI cable, you can control this unit from the remote control of a connected Flat Screen TV, as well as have the connected Flat Screen TV automatically change inputs in response to operations carried out on this unit.

Refer to the operating instructions for your Flat Screen TV for more information about which operations can be carried out by connecting via HDMI cable.

- You cannot use this function with components that do not support HDMI Control.
- We cannot guarantee this unit will work with HDMI Control-compatible components other than those made by Pioneer.

## Making the HDMI Control connections

You can use synchronized operation for a connected Flat Screen TV and up to two other components (including a recorder or player).

Be sure to connect the Flat Screen TV's audio cable to the audio input of this unit.

- HDMI Control may not operate properly if you do not use a High Speed HDMI cable.
- Requires connection of audio cables and additional settings. For details see *Audio input settings from the TVs (TV Input)* on page 46

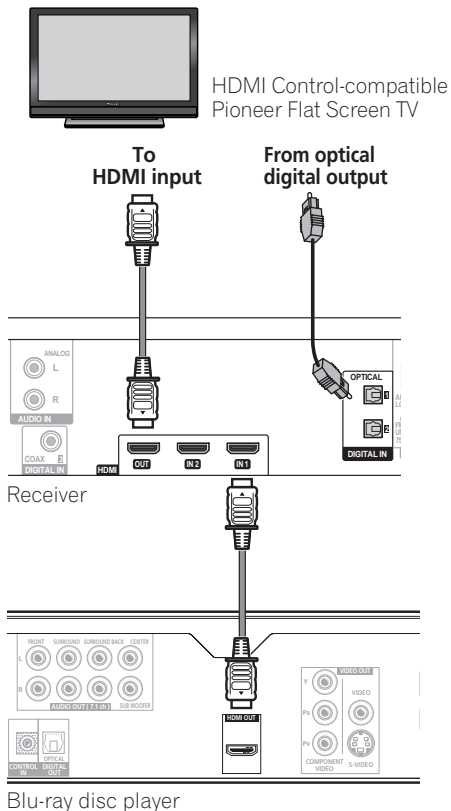

- Connect the Flat Screen TV directly to this unit. Interrupting a direct connection with other amps or an AV converter (such as an HDMI switch) can cause operational errors.

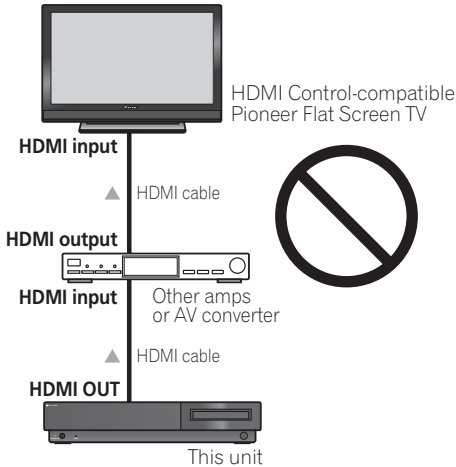

- Only connect components you intend to use as a source to the HDMI input of this unit. Interrupting a direct connection with other amps or an AV converter (such as an HDMI switch) can cause operational errors.

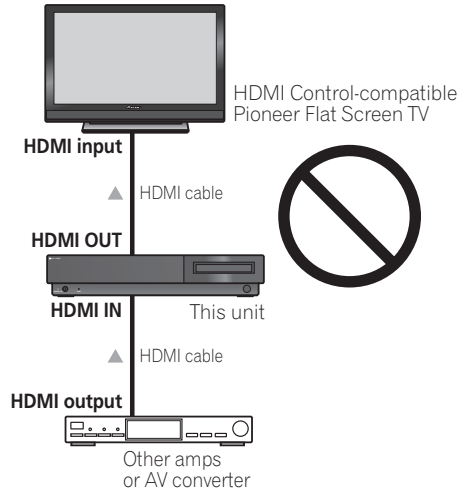

### Important

- When connecting this system or changing connections, be sure to switch the power off and disconnect the power cord from the wall socket. After completing all connections, connect the power cords to the wall socket.
- After connecting this unit to an AC outlet, a 15-second initialization process begins. You cannot carry out any operations during initialization. The **HDMI** indicator on the front panel blinks during initialization, and you can turn this unit on once it has stopped blinking.
- To get the most out of this function, we recommend that you connect your HDMI component not to a Flat Screen TV but rather directly to the HDMI terminal on this unit.

## Setting the HDMI options

You must adjust the settings of this unit as well as HDMI Control-compatible connected components in order to make use of the HDMI Control function. For more information see the operating instructions for each component.

### Setting the HDMI Control mode

Choose whether to set this unit's HDMI Control function **On** or **Off**. You will need to set it to **Control On** to use the HDMI Control function.

- When using a TV not manufactured by Pioneer, put this setting to **Control Off**.

 1 Press **SETUP**.

 2 Select 'HDMI Setup' then press **ENTER**.

 3 Select 'HDMI Ctrl', then press **ENTER**.

 4 Adjust the setting then press **ENTER** to confirm.

- **Control On** – Enables the HDMI Control function. When this unit's power is turned off and you have a supported source begin playback while using the HDMI Control function, the audio and video output from the HDMI connection are output from the Flat Screen TV.
- **Control Off** – The HDMI Control is disabled. Synchronized operations cannot be used. When this unit's power is turned off, audio and video of sources connected via HDMI are not output.

## Before using synchronization

Once you have finished all connections and settings, you must:

- 1 Put all components into standby mode.
- 2 Turn the power **ON** for all components, with the power for the Flat Screen TV being turned on last.
- 3 Choose the HDMI input to which the TV is connected to this unit, and see if video output from connected components displays properly on the screen or not.

## Synchronized amp mode

Synchronized amp mode begins once you carry out an operation for the Flat Screen TV. For more information, see the operating instructions of your Flat Screen TV.

### Synchronized amp mode operations

The synchronized amp mode can be used to perform the following operations when using the iPod function, or when the HDMI cable is used to connect an external component:

- Displays on the Flat Screen TV when you mute or adjust the volume of this unit.
- The input of this unit is automatically changed when playback occurs on a connected component.
- Even if you change this unit's input to a device that is not connected by HDMI, the synchronized amp mode remains in effect.

### Canceling synchronized amp mode

If you cancel synchronized amp mode while connected via HDMI to a Flat Screen TV or while you are watching a TV program, the power for this unit is turned off.

However, the power remains ON when an input other than HDMI is selected (including iPod function).

## Chapter 11

# Additional information

### Optional system settings

All the available settings in the System Setup menu are listed below. See the notes in each section for more information about the settings. The first setting in each section is the default.

1  Press **SETUP**.

2  Select 'System Setup' then press **ENTER**.

3  Choose the setting you want to adjust, then press **ENTER**.

The available settings are shown in the front panel display.<sup>1</sup>

4  Adjust the setting, then press **ENTER** to confirm the settings and exit.

### Setting the sleep timer

The sleep timer switches off the system after about an hour so you can fall asleep without worrying about it.<sup>2</sup>

1  Select 'Sleep Timer' from the System Setup menu, then press **ENTER**.

2  Adjust the setting, then press **ENTER** to confirm the settings and exit.

- **Sleep On** – Switches off after about an hour. The  indicator lights.
- **Sleep Off** – Cancels the sleep timer.

After selecting **Sleep On**, you can press **SLEEP** again to check how much time is left. Each line indicates approximately 12 minutes (remaining):

**Sleep** - - - 

### Dimming the display

You can adjust the brightness of the text in the front panel display.<sup>3</sup>

1  Select 'Dimmer' from the System Setup menu, then press **ENTER**.

2  Adjust the setting, then press **ENTER** to confirm the settings and exit.

- **Dimmer Light** – Brighter setting
- **Dimmer Dark** – Darker setting

#### Note

1 The setup menu is exited automatically after 5 minutes of inactivity.

2 The display dims when the sleep timer is set.

3 The display of the front panel dims when the sleep timer is set, regardless of this setting.



## Changing the display mode

If no operation is performed for one minute, the front panel display and button illumination automatically turns off. The display will turn on again automatically if a command is input or movement is detected by the motion sensor.

To make the display remain on constantly, set the display mode to **Display On**.

1  Select 'Display Mode' from the System Setup menu, then press ENTER.

2  Adjust the setting, then press ENTER to confirm the settings and exit.

- **Auto Display** – Turns off automatically if no operation is performed for one minute.
- **Display On** – Displays constantly.

Even when set to not display, the display is temporarily shown when you carry out a control function.

- The motion sensor detects movement in the left/right and up/down directions within a distance of 2.5 m and an angle of 40° (20° only in the upper direction). Walking towards the unit will reduce the sensing range to 0.7 m.

## Key lock setting

1  Select 'Key Lock' from the System Setup menu, then press ENTER.

2  Adjust the setting, then press ENTER to confirm the settings and exit.

- **Lock On** – Makes the front panel buttons and controls inoperative.
- **Lock Off** – Restores regular use of the front panel buttons and controls.

## Setting up the remote to control your TV

You can use the supplied remote to control your TV. To be able to use this feature you first have to program the remote with a maker code from the following table.

1	2	3
4	5	6
7	8	9

1  Press and hold CLEAR and Use the number buttons to input the maker code for your TV, and press ENTER.

See the following table for the list of maker codes. If there is more than one code given for your make, input the first one in the list.

- If the maker's name of your TV doesn't appear in the table, you will not be able to use this remote to control your TV.

2 **Point the remote towards your TV and press TV Control  to check that the remote works with your TV.**

If the remote is set up correctly, the TV should switch off. If it doesn't and there is another code given for your maker, repeat step 1 with a new code.

## TV Preset code list

Please note that there are cases where only certain functions may be controllable after assigning the proper preset code, or the codes for the manufacturer in the list will not work for the model that you are using.

### Manufacturer Code(s)

**Aiwa** 660  
**Alba** 639  
**Bush** 647  
**Fisher** 635, 638  
**Fujitsu** 648  
**Funai** 640, 658  
**GE** 611, 628  
**General** 629  
**Goldstar** 610, 623, 650  
**Grandiente** 630  
**Grundig** 631, 653  
**Hitachi** 606, 624, 625, 633, 634, 654  
**ITT** 642  
**JVC** 613  
**Magnabox** 612  
**Mitsubishi** 609  
**NEC** 659  
**Nokia** 632, 652  
**Panasonic** 608, 622  
**Philips** 607, 656, 668  
**RCA** 601, 615, 616, 617, 618, 661, 662  
**Salora** 643  
**Samsung** 644, 646, 669, 670  
**Sanyo** 614, 621, 645  
**SEI** 649  
**Sharp** 602, 619, 627, 667  
**Sony** 604  
**Tandy** 641  
**Telefunken** 637  
**Thomson** 636, 663  
**Toshiba** 605, 626  
**Uniden** 671  
**Zenith** 603, 620  
**Pioneer** 600, 651

## Surround sound formats

Below is a brief description of the main surround sound formats you'll find on DVDs, satellite, cable and terrestrial broadcasts, and video cassettes.

### Dolby

The Dolby technologies are explained below. See [www.dolby.com](http://www.dolby.com) for more detailed information.



### Dolby Digital

Dolby Digital is a multichannel digital audio coding system widely used in cinemas, and in the home for DVD and digital broadcast soundtracks. It can deliver up to six discrete audio channels, comprising five full range channels and a special LFE (low frequency effects) channel used mainly for deep, rumbling sound effects; hence the term "5.1-channel" Dolby Digital.

In addition to the format features above, Dolby Digital decoders offer downmixing for compatibility with mono, stereo and Dolby Pro Logic audio from a number of bit rates and channels. Another feature, called Dialog Normalization, attenuates programs based on the average level of dialog in a program relative to its peak level (also known as Dialnorm) in order to achieve uniform playback level.

### Dolby Pro Logic II and Dolby Surround

Using the innovative "steering logic" circuit, this system extracts surround sound from sources as follows:

- **Dolby Pro Logic** – 4.1 channel sound (mono surround) from any stereo source

- **Dolby Pro Logic II** – 5.1 channel sound (stereo surround) from any stereo source

*With two channel sources, the “.1” subwoofer channel is generated by bass management in the receiver.*

Dolby Surround is an *encoding* system which embeds surround sound information within a stereo soundtrack, which a Dolby Pro Logic decoder can then use for enhanced surround listening with greater sound detail.

*Manufactured under license from Dolby Laboratories. Dolby, Pro Logic and the double-D symbol are trademarks of Dolby Laboratories.*

### DTS

The DTS technologies are explained below. See [www.dtstech.com](http://www.dtstech.com) for more detailed information.



### DTS Digital Surround

DTS Digital Surround is a 5.1-channel audio coding system from DTS Inc. now widely used for DVD-Video, DVD-Audio, 5.1 music discs, digital broadcasts, and video games. It can deliver up to six discrete audio channels, comprising five full range channels, including an LFE channel. Higher sound quality is achieved through the use of a low compression rate, and high rates of transmittance during playback.

*Manufactured under license under U.S. Patent #'s: 5,451,942; 5,956,674; 5,974,380; 5,978,762; 6,487,535 & other U.S. and worldwide patents issued & pending. DTS and DTS Digital Surround are registered trademarks and the DTS logos and Symbol are trademarks of DTS, Inc. © 1996-2007 DTS, Inc. All Rights Reserved.*

## Installation and maintenance

### Hints on installation

We want you to enjoy using this system for years to come, so please bear in mind the following points when choosing a location:

#### Do...

- ✓ Use in a well-ventilated room.
- ✓ Place on a solid, flat, level surface, such as a table, shelf or stereo rack.

#### Don't...

- ✗ Use in a place exposed to high temperatures or humidity, including near radiators and other heat-generating appliances.
- ✗ Place on a window sill or other place where the system will be exposed to direct sunlight.
- ✗ Use in an excessively dusty or damp environment.
- ✗ Place directly on top of an amplifier, or other component in your stereo system that becomes hot in use.
- ✗ Use near a television or monitor as you may experience interference — especially if the television uses an indoor antenna.
- ✗ Use in a kitchen or other room where the system may be exposed to smoke or steam.
- ✗ Use on a thick rug or carpet, or cover with cloth — this may prevent proper cooling of the system unit.
- ✗ Place on an unstable surface, or one that is not large enough to support all four of the system unit's feet.

## Troubleshooting

Incorrect operations are often mistaken for trouble and malfunctions. If you think that there is something wrong with this component, check the points below. Sometimes the trouble may lie in another component. Investigate the other components and electrical appliances being used. If the trouble cannot be rectified even after exercising the checks listed below, ask your nearest Pioneer authorized service center or your dealer to carry out repair work.

- If the system does not operate normally due to external effects such as static electricity disconnect the plug from the outlet and insert again to return to normal operating conditions.
- For audio-related problems, please also check the settings of the audio playback device. See the operating instructions for the device for detailed information.

## General

Problem	Remedy
The power does not turn on, or switches off suddenly (an error message may be displayed at startup). Or, the display disappears suddenly and no sound is output.	<ul style="list-style-type: none"> <li>• Leave the unit plugged in, wait for one minute, then switch back on.</li> <li>• Make sure there are no loose strands of wire touching the unit. This could cause the system to shut off automatically.</li> <li>• Check that the speakers are connected correctly.</li> <li>• Make sure there is enough space for ventilation around the unit.</li> <li>• Make sure the voltage of the mains power source is correct for the model.</li> <li>• Try reducing the volume level.</li> <li>• If the problem persists, take it to your nearest Pioneer authorized service center or your dealer for servicing.</li> <li>• Do not block the air intake opening on the bottom as well as the air exhaust opening on the back of this unit.</li> </ul>
No sound is output when an input function is selected.	<ul style="list-style-type: none"> <li>• If you're using the line input, make sure the component is connected correctly and the volume level of your external component (i.e. a portable player, etc.) is adjusted (see <i>Listening to the sound of an external device on this receiver</i> on page 47).</li> <li>• Turn up the volume.</li> <li>• No audio is output from the speakers connected to this unit if HDMI Audio is set to <b>TV</b> (page 51).</li> <li>• No audio is output if a DVI component is connected via HDMI.</li> <li>• Press <b>MUTE</b> on the remote control to turn muting off.</li> </ul>
No sound from surround or center speakers.	<ul style="list-style-type: none"> <li>• Refer to <i>Channel level setting</i> on page 43 to check the speaker levels.</li> <li>• Check that you haven't selected the <b>Auto, Stereo, A.L.C.</b> or <b>Virtual</b> mode (see <i>Listening in surround sound</i> on page 31).</li> <li>• Connect the speakers properly (see <i>Basic connections</i> on page 26).</li> <li>• Confirm audio output and HDMI settings for the external component connected by optical digital cable, coaxial digital cable, or HDMI cable.</li> <li>• If the source is 88.2 kHz/96 kHz, it will be played in stereo.</li> </ul>

Problem	Remedy
No audio signal is output from <b>AUDIO OUT</b> jacks.	<ul style="list-style-type: none"> <li>• Audio input from <b>ANALOG RCA</b> jacks cannot be output from <b>AUDIO OUT</b> jacks.</li> </ul>
No sound from subwoofer.	<ul style="list-style-type: none"> <li>• Check the speaker level settings (see <i>Channel level setting</i> on page 43).</li> <li>• <i>SX-LX08 model only:</i> <ul style="list-style-type: none"> <li>– Check subwoofer for correct connections (see <i>Connect the speakers</i> on page 24).</li> <li>– Be sure subwoofer's power is turned ON.</li> <li>– Raise subwoofer's volume level.</li> </ul> </li> </ul>
Can't operate using the remote control.	<ul style="list-style-type: none"> <li>• Replace the batteries (see <i>Putting the batteries in the remote control</i> on page 9).</li> <li>• Operate within 7 m, 30° of the remote sensor (see <i>Using the remote control</i> on page 9).</li> <li>• Remove any obstacles or operate from another position.</li> <li>• Avoid exposing the remote sensor on the front panel to direct light.</li> <li>• Check that there's nothing mistakenly plugged into the <b>CONTROL IN</b> jack.</li> <li>• For operating the other Pioneer component connected to the <b>CONTROL OUT</b> jack of this unit, make sure that the control cable and either an HDMI or analog audio cable are connected (page 49).</li> <li>• If an object is placed on top of the touch sensor, the sensor will be activated, thus disabling the remote control unit operations. If the action indicator remains continuously lighted, remove any object sitting on the touch sensor panel.</li> </ul>
The front panel display and indicators do not appear.	<ul style="list-style-type: none"> <li>• If the display mode is set to <b>Auto Display</b>, the display will automatically turn off if no operation is performed for a period of one minute. Try performing an operation.</li> </ul>
Motion sensor not working.	<ul style="list-style-type: none"> <li>• The motion sensor is on the front of the unit. Make sure you are within 2.5 m and 40° of the sensor.</li> <li>• Since the motion sensor uses infrared rays, it may not work correctly if placed in direct sunlight or close to heat source.</li> <li>• Minimum unit height must be 25 cm or above from ground level. The sensor will not work properly when located at ground level.</li> <li>• Motion sensor will not work if placed in a fully sealed cabinet (include glass / clear cabinet).</li> </ul>

## Tuner

Problem	Remedy
Considerable noise in radio broadcasts.	<ul style="list-style-type: none"> <li>• Connect the AM antenna (see <i>Basic connections</i> on page 26) and adjust the direction and position for best reception. You may also connect an additional internal or external AM antenna (refer to <i>Connecting external antennas</i> on page 49).</li> <li>• Fully extend the FM wire antenna, position for best reception, and secure to a wall. You may also connect an outdoor FM antenna (see <i>Connecting external antennas</i> on page 49).</li> <li>• Turn off other equipment that may be causing the noise or move it further away.</li> </ul>
Auto tuning does not pick up some stations.	<ul style="list-style-type: none"> <li>• The radio signal is weak. Auto tuning will only detect radio stations with a good signal. For more sensitive tuning, connect an outdoor antenna.</li> </ul>

## HDMI connection

Symptom	Remedy
No picture or sound.	<ul style="list-style-type: none"> <li>• This unit is HDCP-compatible. Check that the components you are connecting are also HDCP-compatible.</li> <li>• Depending on the connected source component, it's possible that it will not work with this unit (even if it is HDCP-compatible).</li> <li>• If the problem still persists when connecting your HDMI component directly to your monitor, please consult the component or monitor manual or contact the manufacturer for support.</li> </ul>
No sound, or sound suddenly ceases.	<ul style="list-style-type: none"> <li>• Check that the HDMI Audio is set to <b>AMP</b>.</li> <li>• If the component is a DVI device, use a separate connection for the audio.</li> <li>• Check the audio output settings of the source component.</li> </ul>
HDMI Control does not function.	<ul style="list-style-type: none"> <li>• Verify that the HDMI cable is firmly connected.</li> <li>• Make sure that this unit's HDMI Control mode is set to <b>Control On</b> (page 55).</li> <li>• Check whether the connected component supports HDMI Control or not. For more information refer to the operating manual of your Flat Screen TV, DVD player, Blu-ray disc player, etc.</li> <li>• This unit does not guarantee HDMI Control-compatible components other than those made by Pioneer.</li> </ul>





## Front panel display messages

Message	Description
<b>192kHz PCM</b>	An operation is prohibited because the source is 176.4 kHz/192 kHz PCM.
<b>2ch Only</b>	An operation is prohibited because it is only applicable to 2 channel sources, while the current source is a multichannel source.
<b>96kHz PCM</b>	An operation is prohibited because the source is 88.2 kHz/96 kHz PCM.

Message	Description
<b>Error MIC!</b>	An error occurred during MCACC setup because the microphone is not connected or is not connected properly.
<b>Error Speaker!</b>	An error occurred during MCACC setup because the speakers are not connected or are not connected properly.
<b>Error SW!</b> (SX-LX08 model only)	When performing <b>MCACC</b> setup, no sound could be detected from subwoofer. Confirm that the subwoofer's power switch is set to ON, and raise subwoofer sound volume to comfortable level, then press <b>ENTER</b> once again.
<b>Exit</b>	Appears when a menu is automatically exited after a set period of inactivity.
<b>HDMI Audio &lt;TV&gt;</b>	Displays when you change the listening mode, the volume level, or some sound settings when the HDMI Audio is set to <b>TV</b> .
<b>HDMI C.ERR 1**</b>	Check if the HDMI cable is properly connected. If the cable is properly connected, this unit may be damaged. In such an event, please contact a Pioneer-authorized service center or your nearest dealer.
<b>HDCP ERROR</b>	Check whether or not the connected component is compatible with HDCP. Some components that are compatible with HDCP still cause this message to be displayed, but so long as there is no problem with displaying video, this is not a malfunction.
<b>Key Lock</b>	The key lock is enabled. See <i>Key lock setting</i> on page 57.
<b>Line Out Mode</b>	Operation is disabled since Line Output is set to <b>Lt/Rt</b> .
<b>Muting</b>	When audio is muted, display appears if Auto MCACC setup is performed.
<b>No MIC</b>	Display appears when Auto MCACC setup is performed without a microphone connected.
<b>Noisy!</b>	Background noise is too high to complete MCACC setup successfully.
<b>Not support</b>	Try adjusting the resolution, DeepColor or other setting for your component.
<b>OC Error1</b> <b>OC Error2</b>	Check whether the speaker cables are short-circuited. If the error message continues to be displayed, contact your Pioneer authorized service center or your dealer for servicing.
<b>Over Temp</b>	Try lowering the volume. If this problem is not fixed by removing and inserting the power cable, this unit may be damaged. In such an event, please contact a Pioneer-authorized service center or your nearest dealer.
<b>Phones In</b>	An operation is prohibited because the headphones are connected.
<b>*** BackUpERR</b>	Contact your Pioneer authorized service center or your dealer for servicing.

## Resetting the system

Use this procedure to reset all system settings to the factory default.

- 1  **Press SETUP.**
- 2  **Select 'Initialize' then press ENTER.**
- 3  **Select 'All Init' then press ENTER.**
  - **Initialize OK?** is displayed.
- 4  **Press ENTER to confirm initialization.**

The system will restart and all the system settings should be reset.

- Note that following settings will be saved, even if the receiver is unplugged.

Display Mode	<b>Display Mode</b>
Line Output	<b>Line Output</b>
TV Input	<b>TV Input</b>
HDMI Audio	<b>HDMI Audio</b>
HDMI Control mode	<b>HDMI Ctrl</b>
Auto Delay	<b>Auto Delay</b>
Storing stations	-

Input function	<b>'HDMI 1', 'Digital 1', etc.</b>
Listening mode	<b>'Auto', 'Action', etc.</b>
Sound Retriever	<b>'Retriever On' or 'Retriever Off'</b>
Sound Field	<b>Sound Field</b>
Tone controls	<b>Bass, Treble, Quiet, Midnight</b>
Bass Mode	<b>Bass Mode</b>
Dialogue Enhancement	<b>Dialogue</b>
Acoustic Calibration EQ	<b>MCACC EQ</b>
Sound Delay	<b>Sound Delay</b>
Center Width	<b>Center Width</b>
Dimension	<b>Dimension</b>
Panorama	<b>Panorama</b>
Channel Level	<b>Channel Level</b>
Speaker Distance	<b>Distance</b>
Dynamic Range Control	<b>D.R.C.</b>
Dual Mono	<b>Dual Mono</b>
Virtual Surround Back	<b>Virtual SB</b>
LFE Attenuator	<b>LFE ATT</b>
CD Type	<b>CD Type</b>



## Specifications (LX03BD model)

### Audio Multi-channel Receiver

- Amplifier section**

RMS Power Output:

Front, Center	100 W per channel (1 kHz, 10 % T.H.D., 4 $\Omega$ )
Surround	50 W per channel (1 kHz, 10 % T.H.D., 8 $\Omega$ )
Subwoofer	100 W (100 Hz, 10 % T.H.D., 4 $\Omega$ )

- FM tuner section**

Frequency range	87.5 MHz to 108 MHz
Antenna	75 $\Omega$ , unbalanced

- AM tuner section**

Frequency range	531 kHz to 1602 kHz
Antenna	Loop antenna

- Input/Output section**

HDMI terminal:	
Input	19-pin x2
Output	19-pin (5 V, 55 mA)
Audio input	Coaxial x1, Optical x2 (Digital) RCA (2-pin) (Analog)
Audio output	RCA (2-pin) (Analog)
Control jack	Input x1, Output x1 (Mini jack)
MCACC input	Mini jack
iPod connector	5 V, 500 mA

- Miscellaneous**

Power requirements	AC 220 V to 240 V, 50 Hz/60 Hz
Power consumption	.55 W
Power consumption in standby	0.7 W (HDMI Control ON) 0.4 W (HDMI Control OFF)
Dimensions	.420 mm (W) x 80 mm (H) x 364 mm (D)
Weight	4.8 kg

### Speaker system

*(Front speakers x2, Center speakers x2, Surround speakers x2, Subwoofer x1)*

- Front speakers**

Enclosure	Closed-box bookshelf type (magnetically shielded)
System	2-way system
Speakers:	
Woofer	5.2 cm cone type x2
Tweeter	2.6 cm semi-dome type
Impedance	4 $\Omega$
Frequency range	200 Hz to 20 kHz
Maximum input power	100 W
Dimensions	
	.80 mm (W) x 196.8 mm (H) x 82 mm (D)
Weight	1.02 kg

- Center speakers**

Enclosure	Closed-box bookshelf type (magnetically shielded)
System	5.2 cm 1-way system
Speakers	5.2 cm cone type
Impedance	8 $\Omega$
Frequency range	200 Hz to 20 kHz
Maximum input power	50 W
Dimensions	
	.80 mm (W) x 80 mm (H) x 82 mm (D)
Weight	0.48 kg

- Surround speakers**

Enclosure	Closed-box bookshelf type (magnetically shielded)
System	2-way system
Speakers:	
Woofer	5.2 cm cone type
Tweeter	2.6 cm semi-dome type
Impedance	8 $\Omega$
Frequency range	200 Hz to 20 kHz
Maximum input power	50 W
Dimensions	
	.80 mm (W) x 115.8 mm (H) x 82 mm (D)
Weight	0.60 kg

- **Subwoofer**

Enclosure	..... Bass-reflex floorstanding type
System	..... 18 cm 1-way system
Speaker	..... 18 cm cone type
Impedance	..... 4 $\Omega$
Frequency range	..... 25 Hz to 1500 Hz
Maximum Input Power	..... 100 W
Dimensions	..... 211 mm (W) x 320 mm (H) x 358 mm (D)
Weight	..... 6.50 kg

### Accessories

- **Receiver box:**

Remote control	..... 1
AA/R6 dry cell batteries (to confirm system operation)	..... 2
AM loop antenna	..... 1
FM antenna	..... 1
Microphone (for Auto MCACC setup)	..... 1
Power cords	..... 2
HDMI cables	..... 2
Speaker cable adaptors (White, Red, Blue, Grey, Purple)	..... 1 each
Cleaning cloth	..... 1
Warranty card	..... 1
Setup Guide	..... 1
These operating instructions	..... 1

- **Speakers box:**

Speaker cables	..... 7
Brackets	..... 2
Screws (for brackets)	..... 4
Speaker stands	..... 2
Non-skid pads (for satellite speakers)	..... 24
Non-skid pads (for subwoofer)	..... 4
Non-skid pads (for speaker stands)	..... 8
Spiral wrap	..... 2



### Note

Specifications and design subject to possible modification without notice, due to improvements.

## Specifications (SX-LX08 model)

- **Amplifier section**

RMS Power Output:	
Front, Center	..... 100 W per channel (1 kHz, 10 % T.H.D., 4 $\Omega$ )
Surround	..... 50 W per channel (1 kHz, 10 % T.H.D., 8 $\Omega$ )

- **FM tuner section**

Frequency range	..... 87.5 MHz to 108 MHz
Antenna	..... 75 $\Omega$ , unbalanced

- **AM tuner section**

Frequency range	..... 531 kHz to 1602 kHz
Antenna	..... Loop antenna

- **Input/Output section**

HDMI terminal:	
Input	..... 19-pin x2
Output	..... 19-pin (5 V, 55 mA)
Audio input	..... Coaxial x1, Optical x2 (Digital) RCA (2-pin) (Analog)
Audio output	..... RCA (2-pin) (Analog)
Subwoofer Pre Out	..... RCA x1
Control jack	..... Input x1, Output x1 (Mini jack)
MCACC input	..... Mini jack
iPod connector	..... 5 V, 500 mA

- **Miscellaneous**

Power requirements	..... AC 220 V to 240 V, 50 Hz/60 Hz
Power consumption	..... 55 W
Power consumption in standby	..... 0.7 W (HDMI Control ON) 0.4 W (HDMI Control OFF)
Dimensions	..... 420 mm (W) x 80 mm (H) x 364 mm (D)
Weight	..... 4.8 kg

## Accessories

Remote control . . . . .	1
AA/R6 dry cell batteries (to confirm system operation) . . . . .	2
AM loop antenna . . . . .	1
FM antenna . . . . .	1
Microphone (for Auto MCACC setup) . . . . .	1
Power cords . . . . .	2
HDMI cables . . . . .	2
Speaker cable adaptors (White, Red, Green, Blue, Grey) . . . . .	1 each
Cleaning cloth . . . . .	1
Warranty card . . . . .	1
Setup Guide	
These operating instructions	



### Note

- Specifications and design subject to possible modification without notice, due to improvements.

## ❖ **Section Two**

**Blu-ray Disc Player**

# **BDP-LX08**

# Contents

## ❖ Section Two

### 01 Before you start

Types of discs/files that can be played . . .	71
Playable discs . . . . .	71
Playable files . . . . .	74

### 02 Player connections

Connecting a TV . . . . .	76
Connecting using the HDMI cable included with this receiver . . . . .	76
Connecting to a TV with no HDMI input . . . . .	79
Connecting the other audio component . . .	80
Connecting using audio cables . . . . .	80
Connecting the power cord . . . . .	82

### 03 Getting Started

Making settings using the Setup Navigator menu . . . . .	83
Using the TOOLS menu . . . . .	86
Erasing the additional data from BD-ROMs . . . . .	87
Switching the video output terminal . . . .	87
Switching the output video resolution . . .	87

### 04 Playback

Playing discs or files . . . . .	90
Forward and reverse scanning . . . . .	91
Playing specific titles, chapters or tracks . . . . .	91
Skipping content . . . . .	91
Playing in slow motion . . . . .	92
Step forward and step reverse . . . . .	92
Switching the camera angles . . . . .	92
Switching the subtitles . . . . .	93
Switching the audio streams/channels . .	93
Switching the secondary audio . . . . .	94
Switching the secondary video . . . . .	94
Displaying the disc information . . . . .	95
Using the Play Mode functions . . . . .	95
Playing from a specific time (Time Search) . . . . .	95
Playing a specific title, chapter or track (Search) . . . . .	96
Playing a specific section within a title or track repeatedly (A-B Repeat) . . . . .	96
Playing repeatedly (Repeat Play) . . . .	97
Playing in random order (Random Play) .	98
About Play Mode types . . . . .	99
Playing from the Home Media Gallery . . .	100
Playing discs . . . . .	100
Playing movie files . . . . .	100
Playing music files . . . . .	102
Playing in the desired order (HMG Playlist) . . . . .	103

### 05 Adjusting audio and video

Adjusting the video . . . . .	105
Adjusting the Audio DRC. . . . .	107

### 06 Advanced settings

Changing the settings (Initial Setup) . . . . .	108
Operating the Initial Setup screen. . . . .	108
Changing to other language at language setting . . . . .	114
Changing the speaker setup . . . . .	114
Adjusting the output level of the various speakers (Channel Level). . . . .	115
Registering or Changing the password . . . . .	116
Changing the Age Restriction for watching BD-ROMs. . . . .	117
Changing the Parental Lock level for watching DVDs. . . . .	117
Changing the Country/Area code . . . . .	119
Changing the terminals for outputting video and audio signals (Output Terminal Priority) . . . . .	119
Restoring all the settings to the factory default settings . . . . .	120
About the audio output settings . . . . .	121

### 07 Additional information

Troubleshooting. . . . .	123
Playback . . . . .	123
When connected using an HDMI cable . . . . .	127
Others. . . . .	128
Language Code Table and Country/ Area Code Table. . . . .	130
Language Code Table . . . . .	130
Country/Area Code Table. . . . .	131







# Chapter 1

## Before you start

### Types of discs/files that can be played

#### Playable discs

Discs with the logo marks below indicated on the disc label, package or jacket can be played.

Disc type	Logo	Application format					
		BDMV <sup>1</sup>	BDAV	DVD-Video	DVD VR	CD-DA DTS-CD	DATA-DISC <sup>2</sup>
BD-ROM		✓	✓	X	X	X	X
BD-R		✓	✓	X	X	X	X
BD-RE		✓	✓	X	X	X	X
DVD-ROM	 	✓	X	✓	X	X	✓
DVD-R		✓	X	✓	✓	X	✓
DVD-R DL (Dual Layer)		✓	X	✓	✓	X	✓
DVD-RW		✓	X	✓	✓	X	✓
DVD+R		✓	X	✓	X	X	✓
DVD+RW		✓	X	✓	X	X	✓
CD-DA (Music CD)		X	X	X	X	✓	X
CD-R		X	X	X	X	✓	✓
CD-RW		X	X	X	X	✓	✓
CD-ROM		X	X	X	X	✓	✓

1. Including the AVCHD format.

2. Discs on which movie files or music files are recorded.

### Discs that cannot be played

- HD DVDs
- DVD Audio discs
- DVD-RAM discs
- Non-finalized DVD-R/DVD-RW/DVD+R/DVD+RW discs in the DVD-Video format and AVCHD format
- Non-finalized Dual Layer DVD-R discs in the DVD VR format
- SACDs
- Video CDs
- SVCDs

"Blu-ray Disc" and  are trademarks.

 is a trademark of DVD Format/Logo Licensing Corporation.



#### Note

- Some discs cannot be played, even if one of the above logo marks is indicated.
- To play 8 cm discs, set the disc in the 8 cm disc depression in the center of the disc tray. No adapter is necessary. 8 cm BD-ROMs cannot be played.

### About audio formats

The following audio formats are supported on this player:

- Dolby TrueHD
- Dolby Digital Plus
- Dolby Digital
- DTS-HD Master Audio
- DTS-HD High Resolution Audio
- DTS Digital Surround
- MPEG
- MPEG-2 AAC
- Linear PCM

To enjoy the surround sound of Dolby TrueHD, Dolby Digital Plus, DTS-HD Master Audio and DTS-HD High Resolution Audio, it is recommended to connect the player to an AV receiver or amplifier compatible with these audio formats using an HDMI cable. After loading a BD containing sound in one of these audio formats, select the audio format on the menu screen.

When connected to this receiver, these audio signals are converted to PCM and output from the HDMI jack.

See *About the audio output settings* on page 121 for the output conditions of the different formats.



*Manufactured under license from Dolby Laboratories. Dolby and the double-D symbol are trademarks of Dolby Laboratories.*





*Manufactured under license under U.S. Patent #: 5,451,942; 5,956,674; 5,974,380; 5,978,762; 6,487,535 & other U.S. and worldwide patents issued & pending. DTS is a registered trademark and the DTS logos, Symbol, DTS-HD and DTS-HD Advanced Digital Out are trademarks of DTS, Inc. © 1996-2007 DTS, Inc. All Rights Reserved.*

### Playing BDs

- BDs (BDMV) compatible with the formats below can be played.
  - Blu-ray Disc Read-Only (ROM) Format Version 2
  - Blu-ray Disc Recordable (R) Format Version 2
  - Blu-ray Disc Rewritable (RE) Format Version 3

This player supports BD-ROM Profile 1 Version 1.1. BONUSVIEW Functions such as playback of secondary video (Picture-in-Picture) and secondary audio can be used. For details on secondary video and secondary audio playback, refer to the disc's instructions.

## BONUS VIEW™

*"BONUSVIEW" is trademark of Blu-ray Disc Association.*

When a BD-ROM is played, additional data may be stored in the player's memory area (local storage). If the message indicating low memory (local storage) appears, erase the BDMV data (page 87).

- BDs (BD-RE) compatible with the formats below can be played.
  - Blu-ray Disc Recordable (R) Format Version 1

- Blu-ray Disc Rewritable (RE) Format Version 2

- Dual Layer BDs can be played.
- Movie and music files recorded on BDs cannot be played.
- 8 cm BD-ROMs cannot be played.

### Playing DVDs

- DVD-Video can be played.
- DVD-R/-RW/+R/+RW discs recorded in the DVD-Video format can be played (finalize them before playing them on this player).
- DVD-R/-RW discs recorded in the VR format (Video Recording format) can be played.
- This label indicates playback compatibility with DVD-RW discs recorded in VR format (Video Recording format). However, for discs recorded with a record-only-once encrypted program, playback can only be achieved using a CPRM compatible device.



- DVDs recorded in the AVCHD format can be played (finalize them before playing them on this player).



*"AVCHD" and the "AVCHD" logo are trademarks of Matsushita Electric Industrial Co., Ltd. and Sony Corporation.*

- Movie and music files recorded on DVD-R/-RW/+R/+RW discs can be played. See *Playable files* on page 74.
- Dual Layer DVDs can be played. However, non-finalized Dual Layer DVD-R discs recorded in the VR format cannot be played (finalize them before playing them on this player).
- HD DVD, DVD Audio and DVD-RAM discs cannot be played.

### About region numbers

Blu-ray Disc Player and BD-ROM or DVD-Video discs are assigned region numbers according to the region in which they are sold.

This player's region numbers are:

- BD-ROM: B
- DVD-Video: 2

Discs not including these numbers cannot be played. Discs playable on this player are as shown below.

- BDs: B (including B) and ALL



- DVDs: 2 (including 2) and ALL



### Playing CDs

- Music CDs (CD-DAs and DTS-CDs) can be played.
- Movie and music files recorded on CDs can be played. See *Playable files* below.
- SACD, Video CD and Super VCD discs cannot be played.
- Regarding copy protected CDs: This player is designed to conform to the specifications of the Audio CD format. This player does not support the playback or function of discs that do not conform to these specifications.

### DualDisc playback

A DualDisc is a new two-sided disc, one side of which contains DVD content — video, audio, etc. — while the other side contains non-DVD content such as digital audio material.

The DVD side of a DualDisc will be played on this player (excluding any DVD-Audio content).

The non-DVD, audio side of the disc is not compatible with this player.

It is possible that when loading or ejecting a DualDisc, the opposite side to that being played will be scratched. Scratched discs may not be playable.

For more detailed information on the DualDisc specification, please refer to the disc manufacturer or disc retailer.

### Playing discs created on computers

- It may not be possible to play DVD-R/-RW or CD-R/-RW discs recorded using a personal recorder or computer. (This can be due to various reasons, including disc properties, scratches, dirt on the disc, dirt on the player's lens, condensation and so on.)
- It may not be possible to play discs recorded using a computer due to the application settings or environment. Record discs in the proper format. For details, contact the dealer.

### Playable files

Movie and music files recorded on DVDs and CDs can be played.



#### Caution

- In DVD, only the one recorded by the ISO 9660 file system can be played.
- Some files may not be playable.
- For some files, it may not be possible to use certain functions during playback.
- It may not be possible to play some files, even if they have the extension of a file playable on this player.
- Files protected by DRM (Digital Rights Management) cannot be played (not including DivX VOD files).

## Supported movie file formats

### • DivX

DivX is a media technology created by DivX., Inc. DivX media files contain not only video but also advanced media features like subtitles and alternate audiotracks, etc.

Conform to the size under 720 x 576 pixels/ 720 x 480 pixels.

DivX files encoded with GMC/Qpel option cannot be played.

Only audio signals with MP3 or Dolby Digital (AC3) format are output.

Note that files other than the ones containing DivX video cannot be played, even if they have the extension “.avi”.



*Official DivX® Certified product.*

*Plays all versions of DivX® video (including DivX® 6) with standard playback of DivX® media files.*

*DivX, DivX Certified, and associated logos are trademarks of DivX, Inc. and are used under license.*



### Note

- DivX VOD files are protected by DRM. They can only be played on registered devices.
  - You may be requested by the file distributor to input the DivX VOD registration code for authorization of the player in order to play DivX VOD files. This player's DivX VOD registration code can be checked at **Initial Setup → Options → DivX VOD → Registration Code** (page 113).

- DivX VOD files for which the player's DivX VOD registration code is not authorized cannot be played (**Authorization Error** is displayed).
- The number of views is restricted for some DivX VOD files. When such files are played on this player, the remaining number of views is displayed. Files for which the remaining number of views has reached 0 cannot be played (**Rental Expired** is displayed). Files for which the number of views is not restricted can be played as many times as you like (the remaining number of views is not displayed).

## Supported music file formats

### • Windows Media™ Audio 9 (WMA9)

Bit rate: Up to 192 kbps

Sampling frequencies: 22.05 kHz, 32 kHz, 44.1 kHz and 48 kHz

*Windows Media is either a registered trademark or trademark of Microsoft Corporation in the United States and/or other countries.*

*This product includes technology owned by Microsoft Corporation and cannot be used or distributed without a license from Microsoft Licensing, Inc.*

### • MPEG-1 Audio Layer 3 (MP3)

Bit rate: Up to 320 kbps

Sampling frequencies: 8 kHz, 11.025 kHz, 12 kHz, 16 kHz, 22.05 kHz, 24 kHz, 32 kHz, 44.1 kHz and 48 kHz

## Playable file extensions

- **Movie files**  
.divx and .avi
- **Music files**  
.wma and .mp3

## Chapter 2

# Player connections

### Connecting a TV

Be sure to turn off the power and unplug the power cord from the power outlet whenever making or changing connections.



#### Note

- Make the settings in the Setup Navigator menu according to the type of cable connected (page 83).

### Connecting using the HDMI cable included with this receiver

The audio and video signals can be transferred to HDMI-compatible devices as digital signals with no loss of sound or video quality. After connecting, make the settings at the **Setup Navigator** menu according to the connected HDMI-compatible device (page 83).

Also refer to the operating instructions of the device being connected.



#### Note

- The HDMI indicator on the player's front panel lights when an HDMI-compatible device is connected. (Depending on the connected device, in some cases it may only light when the player is selected as the device's input.)
- 1080p video signals may not be output, depending on the HDMI cable being used.

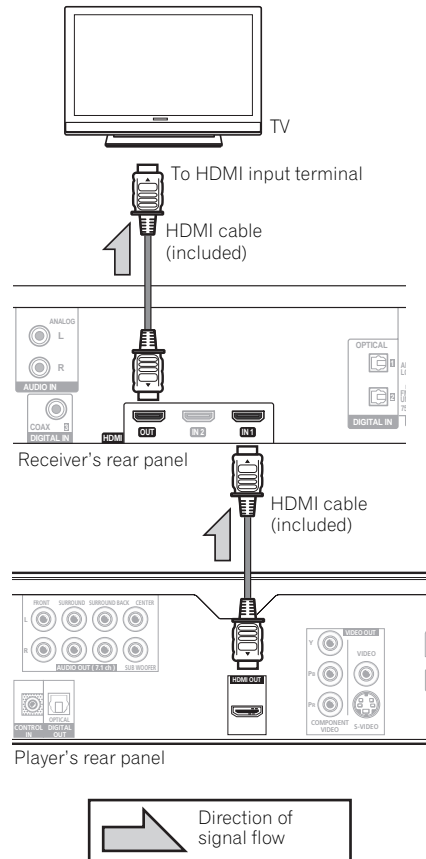

#### Caution

- Hold the plug when connecting and disconnecting the cable.
- Placing a load on the plug could result in faulty contact and no video signals being output.

## About HDMI

This player incorporates High-Definition Multimedia Interface (HDMI™) technology.

The player supports Deep Color. The conventional players can transmit a video signal with 8 bit color depth in the YCbCr 4:4:4 or RGB formats, the players supporting Deep Color can transmit a video signal with a color bit depth of greater than 8 bits per color component. Subtle color gradations can be reproduced when connected to a TV that supports Deep Color.



*HDMI, the HDMI logo and High-Definition Multimedia Interface are trademarks or registered trademarks of HDMI Licensing LLC.*

## Audio signals that can be transferred with the player's HDMI OUT terminal

- Dolby TrueHD
- Dolby Digital Plus
- Dolby Digital
- DTS-HD Master Audio
- DTS-HD High Resolution Audio
- DTS Digital Surround
- MPEG-2 AAC
- Linear PCM

Linear PCM audio signals meeting the following conditions can be output:

- Sampling frequency: 32 kHz to 192 kHz
- Number of channels: Up to 8 (up to 6 for a 192 kHz sampling frequency)

When outputting the bitstream of Dolby TrueHD, Dolby Digital Plus, Dolby Digital, DTS-HD Master Audio, DTS-HD High Resolution Audio, DTS Digital Surround, MPEG or MPEG-2 AAC, these audio signals output in linear PCM from the HDMI terminal to this receiver.

For details, see *About the audio output settings* on page 121.

## About the HDMI high speed transmission

This player outputs 1080/50p, 1080/60p and Deep Color video signals. If your TV supports 1080/50p, 1080/60p or Deep Color signals, use a High Speed HDMI™ cable or the supplied HDMI cable in order to take advantage of the maximum performance the player and TV can offer. Also set **HDMI High-Speed Transmission** to **On** (page 110).

High Speed HDMI™ cables are tested to carry signals up to 1080p. 1080/50i, 1080/50p, 720/50p, 1080/24p, 1080/60i, 1080/60p and 720/60p video signals that are capable of Deep Color can also be carried.



### Note

- Set **HDMI High-Speed Transmission** to **Off** when using an HDMI cable other than a High Speed HDMI™ cable (a Standard HDMI™ cable).
- The following restrictions apply when **HDMI High-Speed Transmission** is set to **Off**:
  - Deep Color signals are not output.
  - If output video resolution is set to **Auto**, the signals are output with a resolution of 1080/50i or 1080/60i when TV's preferred resolution is 1080/50p or 1080/60p.
  - When the output video resolution is set to **576i/480i** or **576p/480p**, Dolby TrueHD and DTS-HD Master Audio signals are not output as such. They are either output as Dolby Digital or DTS Digital Surround signals or converted into linear PCM. Also, 96 kHz and 192 kHz multi-channel linear PCM audio signals cannot be output. They are output as 2-channel signals (page 121).
- When an HDMI cable with a built-in equalizer is connected, it may not operate properly.

### About HDCP

HDCP (High-bandwidth Digital Content Protection) is a copyright protection system by which digital video signals are encrypted.

### When connected to a DVI device

- **It is not possible to connect DVI devices (computer displays, for example) that are not compatible with HDCP.**
- No audio signals are output. Connect using an audio cable (included), etc.
- This player is designed for connection with HDMI-compatible devices. When connected to a DVI device, it may not operate properly depending on the DVI device.

### About HDMI Control function

- When the player is connected to a Pioneer Flat Screen TV or this receiver, supporting the HDMI Control function, it can be operated from the Flat Screen TV or this receiver.
- The Flat Screen TV's input is switched automatically when playback is started on the player or the Home Menu or the Home Media Gallery is displayed. When the input is switched, the playback picture, the Home Menu or the Home Media Gallery appears on the Flat Screen TV (Auto-select function). If the Flat Screen TV's power is being turned off at this time, it may turn on automatically (Simultaneous power function). When the language information from a connected Flat Screen TV is received, you can have the player's on-screen display language change automatically to that of the Flat Screen TV (Unified language function). This function is available only when playback is stopped and the menu screen is not displayed.
- Also refer to the operating instructions of the Flat Screen TV, etc.

### To use the HDMI Control function

- The HDMI Control function operates when HDMI Control is set to On for all devices connected with HDMI cables. Once connections and the settings of all the devices are finished, be sure to check that the player's picture is output to the Flat Screen TV. (Also check after changing the connected devices and reconnecting HDMI cables.) The HDMI Control function may not operate properly if the player's picture is not properly output to the Flat Screen TV.
- Use High Speed HDMI™ cables when using the HDMI Control function. The HDMI Control function may not operate properly if other HDMI cables are used.
- The function name of KURO LINK used on the web and in catalogs is referred to as HDMI Control in the operating instructions and on the player.

### About PQLS function

The PQLS (Precision Quartz Lock System) is a transfer control technology using the HDMI Control function. The player's output signals are controlled from the AV receiver or amplifier to achieve high quality sound playback using the quartz oscillator of AV receiver or amplifier. This eliminates the influence of the jitter generated upon transfer which can adversely affect the sound quality.

- The PQLS function is only activated when the player is connected to a Pioneer AV receiver or amplifier compatible with the PQLS function via HDMI connection.
- The PQLS function is only activated when playing a music CD (CD-DA).
- The PQLS function is activated when the player is set as follows (page 111):  
**HDMI Control: On**  
**PQLS: Auto**
- Also refer to the operating instructions of AV receiver or amplifier.

**Caution**

- This receiver cannot use the PQLS function.

- If the output video resolution is switched when playing a music CD (CD-DA), the PQLS function does not work. This function will work again after playback stops and restarts.

## Connecting to a TV with no HDMI input

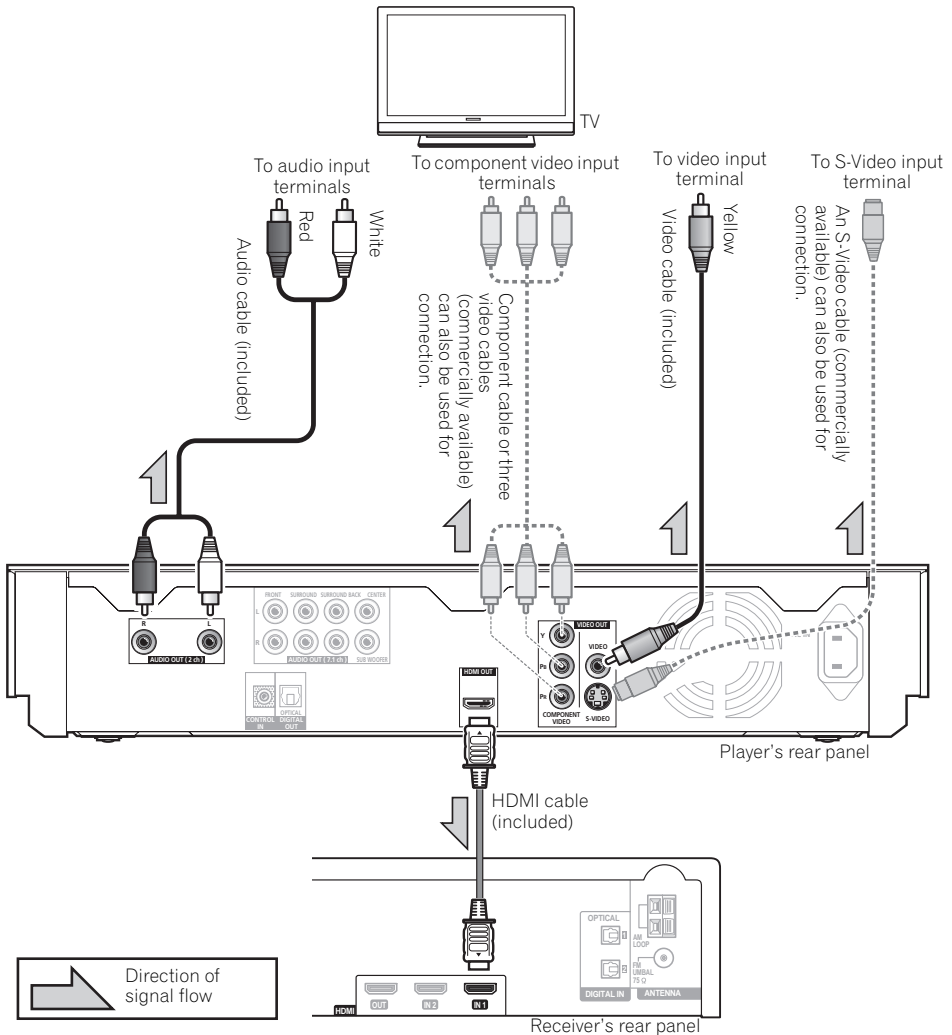

The video signal can also be connected using a separately sold S-Video or component video cable.



### Caution

- When connected to the TV using a component video cable (commercially available), video signals are not output with a resolution of 1080/50i, 1080/50p, 720/50p, 1080/24p or 1080/60p.
- Depending on the output video resolution setting, the picture may not be output (page 87).
- Video signals are output with a resolution of 576/50i or 480/60i when connected using a video cable (included) or an S-Video cable (commercially available).

- **Connect the player's video output directly to your TV.**

This player supports analog copy protection technology. Therefore the picture may not be displayed properly if connected to a TV via a DVD recorder/video deck or when playing the player's output material that is recorded by a DVD recorder/video deck. Furthermore, the picture may not be displayed properly due to the copy protection when the player is connected to a TV with a built-in video deck. For details, contact the manufacturer of your TV.

## Connecting the other audio component

Connect to the other audio component in order to enjoy the surround sound of Dolby TrueHD, Dolby Digital Plus, Dolby Digital, DTS-HD Master Audio, DTS-HD High Resolution Audio or DTS Digital Surround. For instructions on connecting the TV and speakers to the audio component, refer to the operating instructions of audio component.



### Note

- Make the settings in the Setup Navigator menu according to the type of cable connected (page 83).
- To output video signals from this player, connect using one of the following (not including when connected using an HDMI cable): a component video cable (commercially available), an S-Video cable (commercially available) or a video cable (included).

## Connecting using audio cables



### Caution

- For DTS-HD Master Audio and DTS-HD High Resolution Audio signals, the DTS Digital Surround signals are converted to linear PCM for output (page 121).

### When connecting to a 7.1-channel compatible audio component

– Connect using the included audio cable and 3 commercially available audio cables (diagram below).

### When connecting to a 5.1-channel compatible audio component

– Connect using the included audio cable and 2 commercially available audio cables (do not connect to the surround back left and right terminals).

- After connecting, set **Audio Output Mode** to **Multi-channel** (page 110).



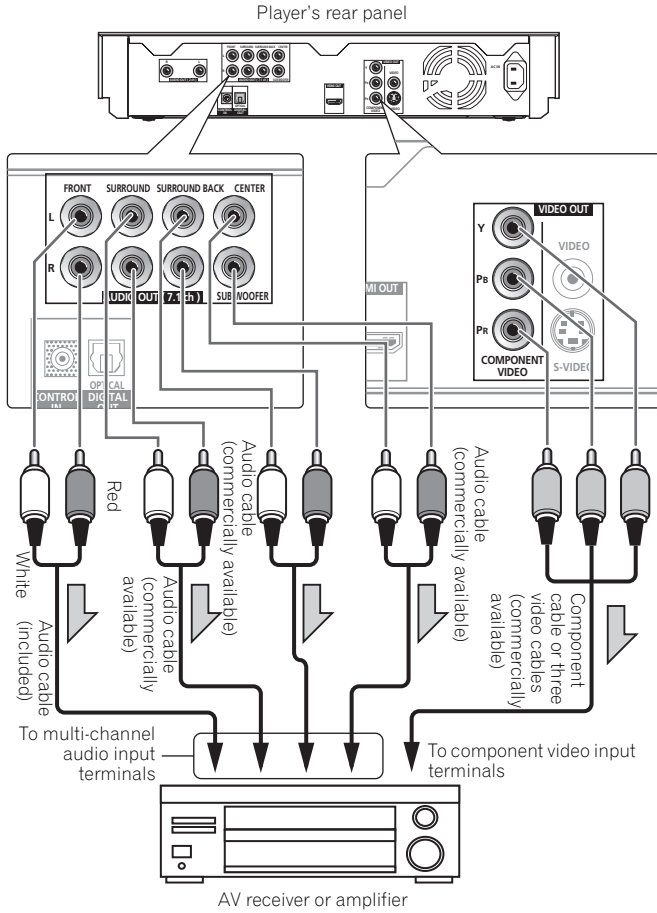

## Connecting the power cord

Connect the power cord after all the connections between devices have been completed.

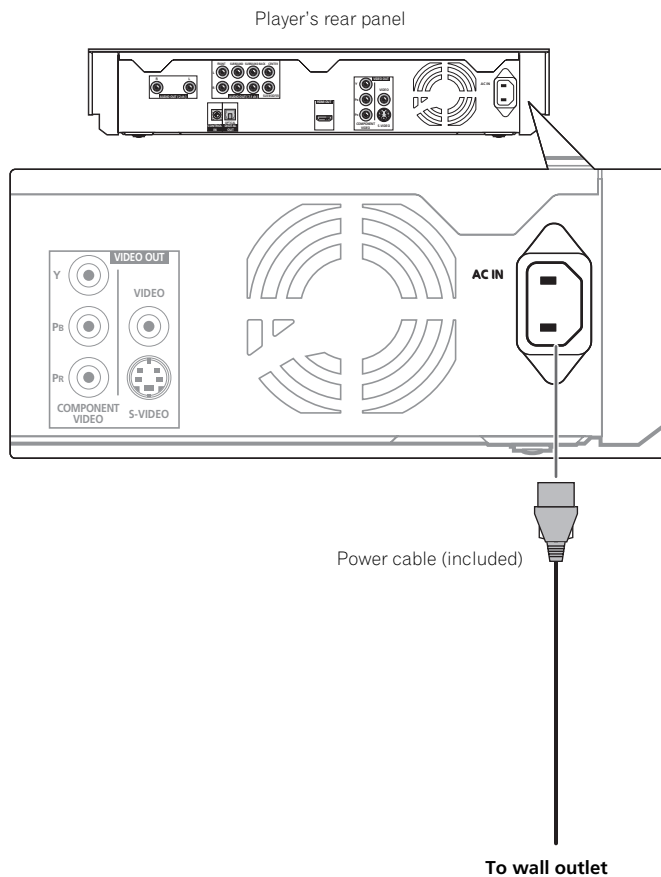

## Chapter 3

# Getting Started

### Important

- Set the remote control operation selector switch to **BD** to operate the Blu-ray disc player.



## Making settings using the Setup Navigator menu

Be sure to perform these settings when using the player for the first time.

### Caution

- Before turning on the power, check that the connections between the player and other devices are correct.

#### 1 Turn on the power.

#### 2 Turn on the TV's power and switch the input.

See the TV's operating instructions for instructions on operating the TV.

Check that the **Setup Navigator** menu is displayed.

If TV Control is set, the TV can be operated with the receiver's remote control (page 86).

### If the Setup Navigator menu is not displayed

- Press **HOME MENU** to display the Home Menu, select **Initial Setup** → **Setup Navigator** → **Start**, then press **ENTER**.

#### 3 Select the OSD language.

Use **↑/↓** to select, then press **ENTER**.



When you have this player connected to a Pioneer Flat Screen TV that is compatible with HDMI Control, language settings are imported from the Pioneer Flat Screen TV's language settings before Setup Navigator begins.

#### 4 Select and set the video and audio output terminals.

Select the actually connected video and audio output terminals.

Use **↑/↓/←/→** to select, then press **ENTER**.

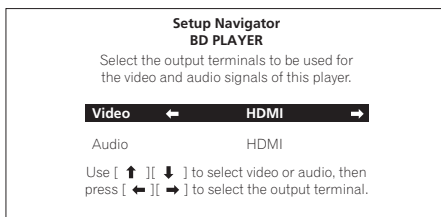

- When **HDMI** is selected for **Video** or **Audio**, proceed to step 5.
- When **Component Video** is selected for **Video**, proceed to step 6.
- When **S-Video/Video** is selected for **Video**, proceed to step 7.

Setting item	Output terminal name	
Video	HDMI	HDMI Output
	Component Video	Video Output    Component Video
	S-Video/Video	S-Video Video
Audio	HDMI	HDMI Output
	Digital Audio	Digital Audio    Optical Output
	Analog Audio	Audio Output (2 ch) Audio Output (7.1 ch)



### Caution

- When **HDMI** is selected for **Video**, no video signals are output from the **COMPONENT VIDEO**, **S-VIDEO** or **VIDEO** output terminals.
- When **Component Video** or **S-Video/Video** is selected for **Video**, no video signals are output from the **HDMI OUT** terminal.
- The video and audio signals output from the set output terminals are output synchronously (lip synchronization).
- Linear PCM audio signals (2 channels) are output from all terminals other than the ones selected for **Audio**, regardless of the audio format or the player's settings.



### 5 Select and set the HDMI High-Speed Transmission setting.

Use **←/→** to select, then press **ENTER**.

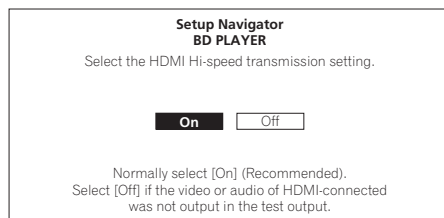

- When **HDMI High-Speed Transmission** is set to **On**, use the supplied HDMI cable or a High Speed HDMI™ cable. The picture and sound may not be output properly if any other HDMI cable (standard HDMI™ cable) is used.
- When **HDMI** is selected for **Video**, proceed to step 8.
- When **Component Video** is selected for **Video**, proceed to step 6.
- When **S-Video/Video** is selected for **Video**, proceed to step 7.



### 6 Select the output video resolution from the COMPONENT VIDEO output terminals.

Use **↑/↓** to select, then press **ENTER**.

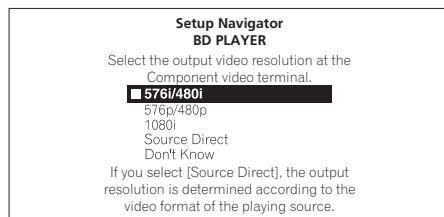

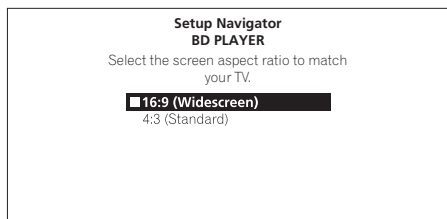

For details on the resolution settings, see *Switching the output video resolution* on page 87.

- 7**  **Select the aspect ratio of your TV.**  
Use **↑/↓** to select, then press **ENTER**.

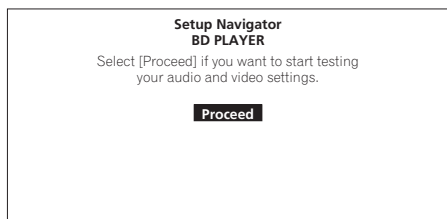

- 8**  **Check the settings.**  
Select **Proceed**, then press **ENTER**.



- 9**  **Output test tones.**  
Use **←/→** to select **Yes**, then press **ENTER**.

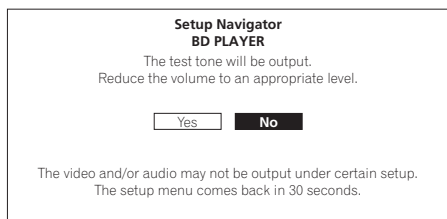

### Caution

- The screen in step 10 and test tones are output simultaneously according to the settings in steps 4 to 7. Lower the volume of the devices connected with the player.

- 10**  **Finish the Setup Navigator menu.**  
Use **←/→** to select **Finish**, then press **ENTER**.

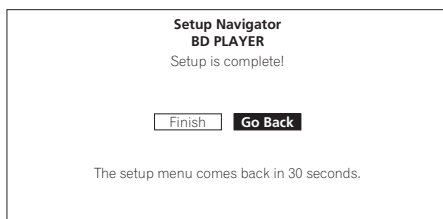

To redo the settings from the start, select **Go Back**.

Depending on the output terminal setting of step 4 or the HDMI cable being used, it may happen that no picture and/or sound is output. If this happens, the setup returns to step 4 if there is no operation for over 30 seconds. Once the setup returns to step 4, redo the settings according to the connected devices and the HDMI cable being used.

### About the screen saver

The screen saver is automatically activated if there is no operation for over 1 minute after playback is stopped or paused. The screen saver turns off when an operation is performed on the player or remote control.

The screen saver is automatically activated if there is no operation for over 1 minute after the Home Menu or Home Media Gallery is displayed while playing a BD or DVD.



With CDs and music files, the screen saver is automatically activated if no button is operated for over 1 minute, even while the CD or music file is playing.

## Using the TOOLS menu

Various functions can be called out according to the player's operating status.

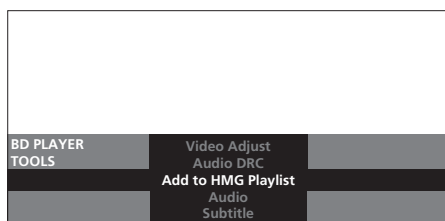
- 1  **Display the TOOLS menu.**



- 2  **Select and set the item.**  
Use / to select, then press **ENTER**.

### Note

- Items that cannot be changed are displayed in gray. The items that can be selected depend on the player's status.

### To close the TOOLS menu

- Press **TOOLS** or **RETURN**.

## TOOLS menu item list

Item	Description
Output Video Resolution	Switch the output video resolution from the various output terminals (page 87).
Play from Beginning	Play the selected title, track or file from the start.
Play Mode	Display the Play Mode screen (page 95).
Angle	Switch the BD-ROM/DVD-Video disc's camera angles (page 92).
Subtitle	Switch the subtitles (page 93).
Audio	Switch the audio streams/channels (page 93).
Secondary Audio	Switch the BD-ROM's secondary audio streams/channels (page 93).
Secondary Video	Switch the BD-ROM's secondary video (Picture-in-Picture) (page 94).
Original/Play List	Switch the DVD-R/-RW's (VR format) list screen between the original list and the playlist.
Add to HMG Playlist	Add the selected track or file to the HMG Playlist (page 103).
Delete from HMG Playlist	Delete the selected track or file from the HMG Playlist (page 104).
Now Playing	Display the playback screen of the currently playing track or file.
Video Adjust	Display the picture quality adjustment screen (page 105).
Audio DRC	Adjust the Audio DRC (page 107).
BDMV Data Erase	Erase the additional data from BD-ROMs.

## Erasing the additional data from BD-ROMs

When a BD-ROM is played, additional data may be stored in the player's memory (local storage).

If the message indicating low memory (local storage) appears, erase the BDMV data.

### Caution

- When the BDMV data is erased, all the data of secondary video (Picture-in-Picture), secondary audio, bookmark, etc. that has been stored is erased.



### 1 Display the Tools menu.

With no disc loaded, press the **TOOLS** button.

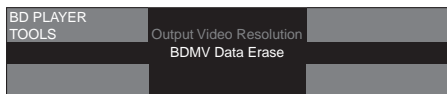

### 2 Select and set the item.

Use **↑/↓** to select **BDMV Data Erase**, then press **ENTER**.



### 3 Erase the data.

Use **←/→** to select **Yes**, then press **ENTER**.

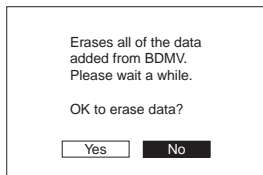

### Caution

- It takes time to erase the BDMV data for a while. Do not unplug the power cord for about 10 seconds after performing the above procedure.

## Switching the video output terminal

Use the procedure below to switch the video output terminal. Switch between the digital output (**HDMI OUT** terminal) and the analog output (**COMPONENT VIDEO**, **S-VIDEO** or **VIDEO** output terminals).



### Switch the terminal from which the video signals are output.

The video output terminal switches each time the button is pressed.



### Caution

- The picture may not be displayed for a while when the video output terminal is switched.
- When the **HDMI OUT** terminal is selected, no video signals are output from the other video output terminals.
- When a video output terminal other than the **HDMI OUT** terminal is selected, no video signals are output from the **HDMI OUT** terminal. However, audio signals are output.

## Switching the output video resolution

Use the procedure below to switch the output video resolution from the various video output terminals.



• **Press OUTPUT RESOLUTION.**

The current output video resolution is displayed on the TV screen and on the player's front panel display.

When pressed again, the output video resolution switches.

**Example:**

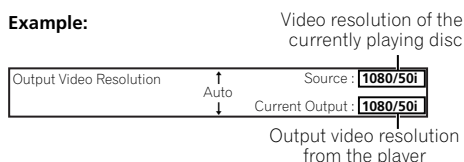

The output video resolution can also be switched using **↑/↓**.

The output video resolution can be switched by selecting **Output Video Resolution** from the **TOOLS** menu.

The output video resolution depends on the video output terminal. See the table below.

The table below shows the output video resolution for the different terminals when the frame/field frequency of the playback source is 50 Hz on the upper line, the resolutions when the source's frame/field frequency is 60 Hz on the lower line.

Output video resolution setting	HDMI OUT terminal	COMPONENT VIDEO output terminals <sup>1</sup>	S-VIDEO/VIDEO output terminal <sup>1</sup>	TV system
Auto <sup>2</sup>	Resolution preferred by TV <sup>3,4</sup>	—	—	PAL * <sup>5</sup>
576i or 480i	576/50i	576/50i	576/50i	PAL
	480/60i	480/60i	480/60i	* <sup>5</sup>
576p or 480p	576/50p	576/50p	576/50i	PAL
	480/60p	480/60p	480/60i	* <sup>5</sup>
1080i	1080/50i	576/50p	576/50i	PAL
	1080/60i	1080/60i <sup>6</sup>	480/60i	* <sup>5</sup>
1080p <sup>2</sup>	1080/50p <sup>7</sup>	—	—	PAL
	1080/60p <sup>7</sup>	—	—	* <sup>5</sup>
Source Direct	Resolution recorded on disc <sup>3,8,9</sup>	Resolution recorded on disc <sup>8,9,10</sup>	576/50i	PAL
			480/60i	* <sup>5</sup>

1. Depending on the BD, the pictures may not be output.
2. Cannot be selected when the video signals are being output from the **COMPONENT VIDEO** output terminals, **S-VIDEO** output terminal or the **VIDEO** output terminal.
3. For details on the output of film material (1080/24p or 720/24p video signals), see *To output film material*.
4. Sources with a resolution of 720/50p, 720/60p and 720/24p are output at 1080/50i or 1080/60i, even if the TV's preferred resolution is 1080/50p or 1080/60p.
5. Depends on the **NTSC on PAL TV** setting (page 109).
6. DVD-Video or DVD VR format is output at 480/60p. BDs format may be output at 480/60p.
7. Depending on the connected HDMI cable, the video signals may not be output. Also, sources with a resolution of 720/50p is output at 1080/50i, and 720/60p and 720/24p are output at 1080/60i.
8. Depending on the connected TV, the video signals may not be output.
9. 720/24p film material is output at 720/60p.
10. 1080/24p film material is output at 1080/60i.





### Caution

- On some TVs, the picture may not be displayed properly when the resolution is switched. If this happens, use **OUTPUT RESOLUTION** to set to a resolution at which the picture is properly displayed.
- When video signals are being output with a resolution of 1080/50i, 1080/50p, 720/50p, 1080/24p, 1080/60i, 1080/60p or 720/60p from the **HDMI OUT** terminal or **COMPONENT VIDEO** output terminals, the picture may be output with an aspect ratio of 16:9, even if the **TV Aspect Ratio** is set to **4:3 (Standard)**.
- The picture may not be displayed for a while when the resolution is switched.

## About the frame/field frequency and NTSC/PAL TV systems

By factory default setting, the frame/field frequency is set for an output of 50 Hz, and the video signal output from the **S-VIDEO** and **VIDEO** output terminals is set to be output in the PAL TV system format. When sources with a frame/field frequency of 60 Hz or 24 Hz are played, the output frame/field frequency automatically switches to 60 Hz (or 24 Hz for HDMI, depending on the setting), and the TV system format for the video signal output from the **S-VIDEO** and **VIDEO** output terminals is set to **NTSC on PAL TV**. When playback is stopped, the frame/field frequency and TV system settings remain at the settings last used. The frame/field frequency and TV system settings do not change even when the power is turned off. They only switch when a video material with a different frame/field frequency is played.

If the picture is not displayed on the TV when a source with a different frame/field frequency is played, use the procedure below to switch the frame/field frequency and TV system settings for the signal output from the player.

Eject the disc, then press the **▲ OPEN/CLOSE** button on the front panel while pressing the **▶ PLAY** button to switch to a different frame/field frequency. The frame/field frequency switches between 50 Hz and 60 Hz each time this operation is performed. The indicator for the frame frequency's current setting lights on the front panel display (page 14).

## About Film material

The film material is a video signal with a frame rate of 24 frames/second. For example, these materials include 1080/24p, 720/24p, etc.

### Example:

Video resolution of the currently playing disc



Output video resolution from the player

## To output film material

To output 1080/24p film material from the **HDMI OUT** terminal, set the output video resolution to either **Auto** or **Source Direct**.



### Caution

- 1080/24p signals can only be output from the **HDMI OUT** terminal. They cannot be output from other video terminals.
- When **Auto** is selected, the picture is output at 60 frames/second if your TV is not compatible with 1080/24p signals.
- When **Source Direct** is selected, the signals are output as such, even if your TV is not compatible with 1080/24p signals. If the picture is not displayed properly, use **OUTPUT RESOLUTION** to set to the output video resolution at which the picture is properly displayed.
- 720/24p video signals are output at 60 frames/second, even if the resolution is set to **Auto** or **Source Direct**.

## Chapter 4

# Playback

### Important

- Set the remote control operation selector switch to **BD** to operate the Blu-ray disc player.





## Playing discs or files

This section describes the player's main operations.

For the types of discs that can be played, see *Playable discs* on page 71. For the types of files that can be played, see *Playable files* on page 74. Movie and music files recorded on discs are played with Home Media Gallery (page 100).





- 1**  **Press  BD to turn on the power.**  
Turn the TV's power on and switch its input beforehand.

- 2**  **Press  OPEN/CLOSE on the front panel to open the disc tray and load the disc.**

### Note

- Load the disc with the printed side facing up.
- Several dozen seconds are required to read the disc. Once reading is completed, the type of disc is displayed on the player's front panel display.



- 3**  **Press  (play) to play the disc.**  
To pause, press  (pause) during playback.  
To stop, press  (stop) during playback.



### Note

- Some discs start playing automatically when the disc tray is closed.
- DVD-Video discs have parental lock features. Input the password registered in the player's settings to unlock the parental lock. For details, see page 117.
- For some BD-R/-RE, playback protection is set for the disc or titles. Input the code number set for the disc to unlock the protection.

### If the disc menu is displayed

For some discs, the disc menu is displayed automatically when playback starts. The contents of the disc menu and the way to operate differ from disc to disc.

### Resuming playback from where it was stopped (resume playback function)

- When  (stop) is pressed during playback, the point at which the disc stopped is stored in the memory. When  (play) is pressed, playback resumes from that point.
- For CDs and music files, playback starts from the beginning of the track/file that was playing.
- To cancel the resume playback function, press  (stop) while playback is stopped.

## Note

- The resume playback function is canceled automatically in the following cases:
  - When the disc tray is opened.
  - When the file list window is switched.
  - When the power is turned off. (For BDs and DVDs this does not cancel the resume playback function.)
- The resume playback function cannot be used for some discs.

## Forward and reverse scanning



1 During playback, press or .

- The scanning speed switches each time the button is pressed. The speed steps depend on the disc or file (the speed is displayed on the TV screen).
- Forward or reverse scanning is also possible by holding the button down. Normal playback resumes when the button is released.

## Note

- No sound is output when scanning BDs, DVDs and movie files.
- Sound is output when scanning CDs and music files.
- For some discs, normal playback resumes automatically when the chapter switches.

## To resume normal playback

- Press (play).

## Playing specific titles, chapters or tracks



- **Input the number of the title, chapter or track you want to play.**

- Use the number buttons (0 to 9) to input the number, then press **ENTER**.

## Note

- For some discs, it is not possible to specify and play titles, chapters or tracks.
- Press **CLEAR** to clear the values you have input.

## Skipping content



- **Press or .**
- When is pressed, the disc skips ahead to the beginning of the next title/chapter/track/file.
- When is pressed, the disc skips back to the beginning of the currently playing title/chapter/track/file. Press twice to skip back to the beginning of the previous title/chapter/track/file.

## Note

- There are some discs for which skipping is not possible.

## Playing in slow motion

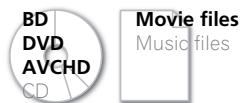

- While playback is paused, press and hold or .
  - The speed switches each time the button is pressed (the speed is displayed on the TV screen). The speed steps depend on the disc or file.

### Note

- It is not possible to switch the speed during reverse slow motion playback.
- No sound is output during slow motion playback.
- For some discs, normal playback resumes automatically when the chapter switches.
- Reverse slow motion playback is not possible with movie files.
- There are some discs for which slow motion playback is not possible.

## To resume normal playback

- Press (play).

## Step forward and step reverse

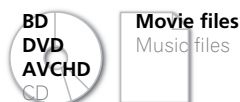

- While playback is paused, press or .
  - The disc moves a step forward or reverse each time the button is pressed.

### Note

- For some discs, normal playback resumes automatically when the chapter switches.
- Reverse step playback is not possible with movie files.
- There are some discs for which step forward/reverse playback is not possible.

## To resume normal playback

- Press (play).

## Switching the camera angles

For BD-ROM and DVD-Video discs on which multiple angles are recorded, the angles can be switched during playback.



- During playback, press **ANGLE**.
  - The current angle and total number of recorded angles are displayed on the TV screen and on the player's front panel display. When pressed again, the angle switches.

**Example:** Current angle/Total number of recorded angles

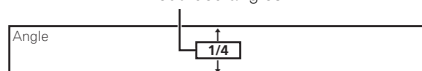

- The angles can also be switched using .
- The angles can also be switched by selecting **Angle** from the **TOOLS** menu.
- Angle mark is displayed for scenes at which multiple angles are recorded.

**Note**

- For some discs, the angle can also be switched on the menu screen.
- Angle mark  is not displayed if **Angle/Secondary Indicator** is set to **Off** (page 113).

## Switching the subtitles

For discs or files on which multiple subtitles are recorded, the subtitles can be switched during playback.

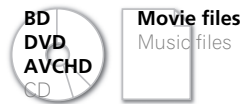

-  **During playback, press SUBTITLE.**
- The current subtitle and total number of recorded subtitles are displayed on the TV screen and on the player's front panel display. When pressed again, the subtitle switches.

**Example:** Current subtitle/Total number of recorded subtitles

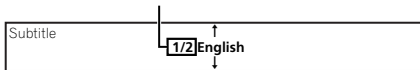

- The subtitles can also be switched using **↑/↓**.
- The subtitles can also be switched by selecting **Subtitle** from the **TOOLS** menu.

**Note**

- In some cases the subtitle may switch or the switching screen provided on the disc may be displayed immediately, without the current subtitle or the total number of subtitles recorded on the disc being displayed.
- The types of recorded subtitles depend on the disc and file.

- If the subtitles are not switched when **SUBTITLE** is pressed, switch them from the menu screen.
- This player does not support the display of external subtitle files for DivX.

## Turning the subtitles off

- Press **SUBTITLE**, then press **CLEAR**.

## Switching the audio streams/channels

For discs or files on which multiple audio streams/channels are recorded, audio streams/channels can be switched during playback.



-  **During playback, press AUDIO.**
- The current audio stream/channel and total number of recorded audio streams/channels are displayed on the TV screen and on the player's front panel display. When pressed again, the audio stream/channel switches.

**Example:** Current audio stream/Total number of recorded audio streams

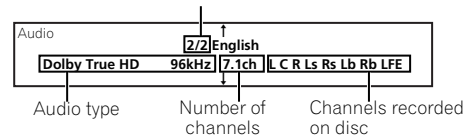

- The audio streams/channels can also be switched using **↑/↓**.
- The audio streams/channels can also be switched by selecting **Audio** from the **TOOLS** menu.

**Note**

- The types of recorded audio streams/channels depend on the disc and file.
- If the audio stream/channel is not switched when **AUDIO** is pressed, switch it from the menu screen.

**Switching the secondary audio**

Use the procedure below switch the secondary audio recorded on the BD-ROM.

**TOOLS****1 Display the TOOLS menu.**

During playback, press **TOOLS**.

**2 Select and set the item.**

Use **↑/↓** to select **Secondary Audio**, then press **ENTER**.

- The current secondary audio stream/channel and total number of recorded secondary audio streams/channels are displayed on the TV screen and on the player's front panel display.

**3 Use ↑/↓ to select secondary audio.**

- Secondary audio mark is displayed for scenes at which secondary audio is recorded.

**Example:**

Current secondary audio stream/Total number of recorded secondary audio streams

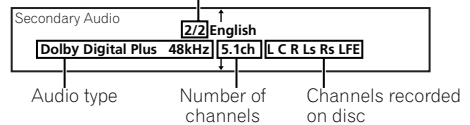
**Note**

- In some cases the secondary audio may switch or the switching screen provided on the disc may be displayed immediately, without the current secondary audio or the total number of secondary audio streams recorded on the disc being displayed.
- The types of recorded audio streams/channels depend on the disc and file.
- Some BD-ROMs do not include secondary audio.
- Secondary audio mark is not displayed if **Angle/Secondary Indicator** is set to **Off** (page 113).

**Switching the secondary video**

Use the procedure below to switch the secondary video (Picture-in-Picture) recorded on the BD-ROM.

**TOOLS****1 Display the TOOLS menu.**

During playback, press **TOOLS**.



## 2 Select and set the item.

Use **↑/↓** to select **Secondary Video**, then press **ENTER**.

- The current secondary video stream and total number of recorded secondary video streams are displayed on the TV screen and on the player's front panel display.



## 3 Use **↑/↓** to select secondary video.

**Example:** Current secondary video stream/Total number of recorded secondary video streams

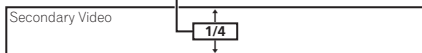

- Secondary video mark is displayed for scenes at which secondary video is recorded.



### Note

- In some cases the secondary video may switch or the switching screen provided on the disc may be displayed immediately, without the current secondary video or the total number of secondary video streams recorded on the disc being displayed.
- Some BD-ROMs do not include secondary video.
- Secondary video mark is not displayed if **Angle/Secondary Indicator** is set to **Off** (page 113).

## Displaying the disc information

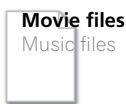

DISPLAY



## Press DISPLAY.

The disc information appears on the TV screen. The information switches each time the button is pressed.

The information display differs during playback and when playback is stopped.

## Using the Play Mode functions

### Playing from a specific time (Time Search)



TOOLS

## 1 Display the TOOLS menu.

During playback, press **TOOLS**.



## 2 Select and set the item.

Use **↑/↓** to select **Play Mode**, then press **ENTER**.



## 3 Select Time Search.

Use **↑/↓** to select, then press **ENTER**.

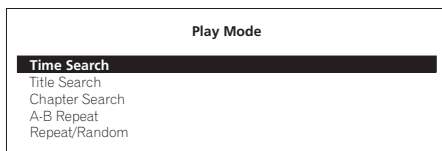

## 4 Input the time.

Use the number buttons (0 to 9) or **↑/↓** to input the time.

Use **←/→** to move the cursor.

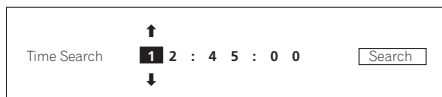

 **Note**

- To play from 45 minutes, input **0, 0, 4, 5, 0** and **0**, then press **ENTER**.
- To play from 1 hour 20 minutes, input **0, 1, 2, 0, 0** and **0**, then press **ENTER**.
- Press **CLEAR** to clear the values you have input.

**5 Starting playback from the specified time.**

Use **←/→** to select **Search**, then press **ENTER**.

**To cancel Time Search**

- Press **RETURN**.

 **Note**

- There are some discs for which Time Search is not available.

**Playing a specific title, chapter or track (Search)**

**1 Display the TOOLS menu.**

**2 Select and set the item.**

Use **↑/↓** to select **Play Mode**, then press **ENTER**.

**3 Select the type of search.**

Use **↑/↓** to select, then press **ENTER**.

See the table on page 99 for the search types.

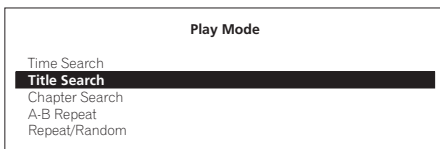
**4 Input the number.**

Use the number buttons (0 to 9) or **↑/↓** to input the number.

Use **←/→** to move the cursor.

**5 Starting playback from the specified title, chapter or track.**

Use **←/→** to select **Search**, then press **ENTER**.

**To cancel the search**

- Press **RETURN**.

 **Note**

- To search for title 32, input **0, 3** and **2**, then press **ENTER**.
- There are some discs for which searching is not available.
- Press **CLEAR** to clear the values you have input.

**Playing a specific section within a title or track repeatedly (A-B Repeat)**

Use this procedure to play a specific section within a title or track repeatedly.



**1 Display the TOOLS menu.**

During playback, press **TOOLS**.



**2 Select and set the item.**

Use **↑/↓** to select **Play Mode**, then press **ENTER**.

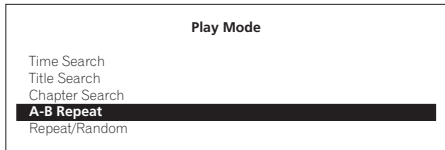

- 3**  **Select A-B Repeat.**  
Use **↑/↓** to select, then press **ENTER**.



- 4**  **Select the starting point for A-B Repeat.**  
Use **←/→** to select **A (Start)**, then press **ENTER**.



- 5**  **Select the end point for A-B Repeat.**  
Use **←/→** to select **B (End)**, then press **ENTER**.  
A-B Repeat playback starts.

### To cancel A-B Repeat play

- Select **Off** from the Repeat/Random screen, then press **ENTER**.
- During playback, press **■** (stop) or **CLEAR**.

### Note

- A-B Repeat play is canceled in the following cases:
  - When the angle is switched (for BD-ROM and DVD-Video discs only).
  - When you search outside the repeat range.
  - When you start other repeat or random play.

### Playing repeatedly (Repeat Play)

Use this procedure to play the currently playing disc, title, chapter, track or file repeatedly.

- 1**  **Display the TOOLS menu.**  
During playback, press **TOOLS**.

- 2**  **Select and set the item.**  
Use **↑/↓** to select **Play Mode**, then press **ENTER**.

- 3**  **Select Repeat/Random.**  
Use **↑/↓** to select, then press **ENTER**.

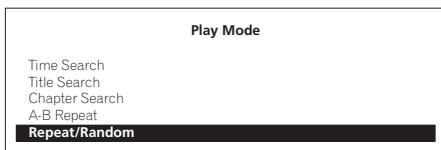

- 4**  **Select the type of Repeat Play.**  
Use **↑/↓** to select, then press **ENTER**.

See the table on page 99 for the types of repeat playback.

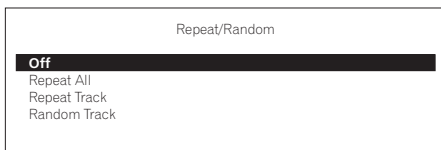

### To cancel Repeat Play

- Select **Off** from the Repeat/Random screen, then press **ENTER**.
- During playback, press **■** (stop) or **CLEAR**.

**Note**

- There are some discs and files for which Repeat Play is not available.
- The type of repeat modes depends on the disc and file being played. See the table on page 99.
- Repeat Play is canceled in the following cases:
  - When the angle is switched (for BD-ROM and DVD-Video discs only).
  - When you search outside the repeat range.
  - When you start other repeat or random play.

**Playing in random order (Random Play)**

Use this procedure to play the tracks or files in random order.

**1 TOOLS Display the TOOLS menu.**

During playback, press **TOOLS**.

**2 Select and set the item.**

Use **↑/↓** to select **Play Mode**, then press **ENTER**.

**3 Select Repeat/Random.**

Use **↑/↓** to select, then press **ENTER**.

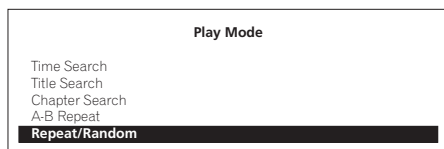
**4 Select the Random Play.**

Use **↑/↓** to select, then press **ENTER**.

**To cancel Random Play**

- Select **Off** from the Repeat/Random screen, then press **ENTER**.
- During playback, press **■** (stop) or **CLEAR**.

**Note**

- There are some discs and files for which Random Play is not available.
- Random Play is canceled in the following cases:
  - When you use the search function.
  - When you start repeat play.

## About Play Mode types

The functions that can be used differ according to the type of disc and file. In some cases, some of the functions cannot be used. Check the usable functions on the table below.

Play Mode type	Mark <sup>1</sup>	Disc/file type								
		BD-ROM <sup>2</sup>	BD-R BD-RE	DVD-Video <sup>2</sup>	DVD-R DVD-RW (VR format)	AVCHD	Movie file	Music file	CD	
Repeat play	Playing a specific section within a title or track repeatedly (A-B Repeat)	A-B	✓	✓	✓	✓	✓	✓	✗	✓
	Playing a title repeatedly (Title Repeat)		✓	✓	✓	✓	✓	✓	✗	✗
	Playing a chapter repeatedly (Chapter Repeat)		✓	✓	✓	✓	✓	✗	✗	✗
	Playing a track or file repeatedly (Track Repeat)		✗	✗	✗	✗	✗	✗	✓	✓
	Playing all the titles, tracks or files on the disc repeatedly (All Repeat)		✗	✓	✗	✓ <sup>3</sup>	✗	✓ <sup>4</sup>	✓ <sup>5</sup>	✓ <sup>6</sup>
Random play	Playing the tracks or files in random order (Random Track)	RDM	✗	✗	✗	✗	✗	✗	✓	✓
Search	Playing from a specific time (Time Search)	—	✓	✓	✓	✓	✓	✗	✓	
	Playing a specific title (Title Search)	—	✓	✓	✓	✓	✗	✗	✗	
	Playing a specific chapter (Chapter Search)	—	✓	✓	✓	✓	✗	✗	✗	
	Playing a specific track (Track Search)	—	✗	✗	✗	✗	✗	✗	✓	

1. During playback in a Play Mode, the type of Play Mode is indicated by the mark.

2. For BD-ROM and DVD-Video discs, some of the functions cannot be used with some titles.

3. The original titles are played repeatedly. However, the playlist titles cannot be played repeatedly.

4. The files in the folder are played repeatedly.

5. The files in the folder or HMG Playlist are played repeatedly.

6. The tracks in the disc or HMG Playlist are played repeatedly.

## Playing from the Home Media Gallery

The Home Media Gallery lets you display a list of the titles, tracks or files recorded on the disc. The discs that can be played from the Home Media Gallery are as shown below (see also page 71).

- BD-R/-RE discs
- DVDs recorded in VR format
- Music CDs (CD-DAs and DTS-CDs)
- DVDs/CDs on which only data files of movie or music files, etc. are recorded

### Playing discs



**1** Press **HOME MEDIA GALLERY** to display the Home Media Gallery.

The Home Media Gallery can also be displayed by selecting **Home Media Gallery** from Home Menu then pressing **ENTER**.



**2** Select the disc.  
Use **↑/↓** to select, then press **ENTER**.

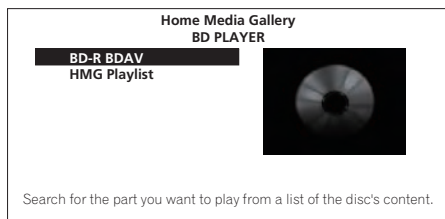

**3** Select the title or track to be played.

Use **↑/↓** to select, then press **ENTER**.

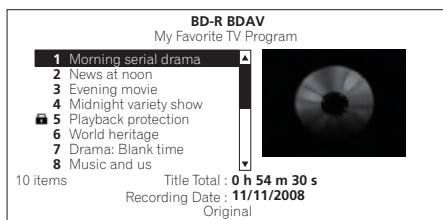

Playback starts.

### Closing the Home Media Gallery

- Press **HOME MEDIA GALLERY** (or **HOME MENU**).



#### Note

- When playing a music CD (CD-DA or DTS-CD), the Now Playing screen is displayed.
- Some BD-R/-RE discs have playback protection. To cancel the protection, input the password set for the disc.
- To play DVD-R/-RW (VR format) playlists, switch to the playlist using the **Original/Play List** command on the **TOOLS** menu (page 86).

### Playing movie files



**1** Press **HOME MEDIA GALLERY** to display the Home Media Gallery.

The Home Media Gallery can also be displayed by selecting **Home Media Gallery** from Home Menu then pressing **ENTER**.



**2 Select the disc.**  
Use **↑/↓** to select, then press **ENTER**.

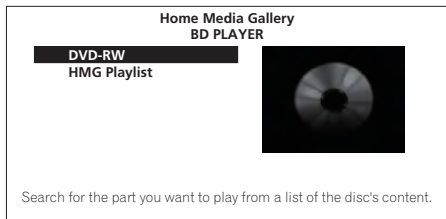

**3 Select Movies.**  
Use **↑/↓** to select **Movies**, then press **ENTER**.

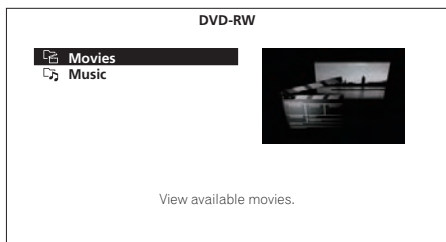

**4 Select Folders or All Movies.**  
Use **↑/↓** to select, then press **ENTER**.

- **Folders** – The files in the selected folder are displayed.
- **All Movies** – All the recorded files are displayed.

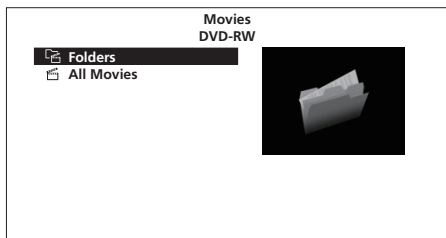

If you have selected **All Movies**, proceed to step 6.



**5 Select the folder containing the file you want to play.**  
Use **↑/↓** to select, then press **ENTER**.

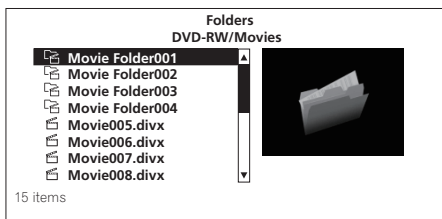

A list of the files and/or the sub-folders in the selected folder is displayed.



**6 Select and set the file you want to play.**  
Use **↑/↓** to select, then press **ENTER**.

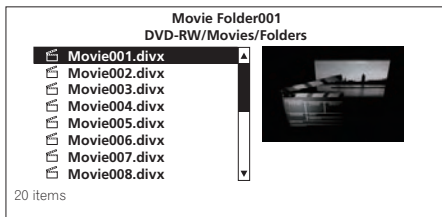

Playback starts.



**Note**

- It may take a few seconds before playback starts. This is normal.
- It may not be possible to play some files properly.
- The number of views may be restricted (page 75).

### Playing music files

**1**  Press **HOME MEDIA GALLERY** to display the Home Media Gallery.  
The Home Media Gallery can also be displayed by selecting **Home Media Gallery** from Home Menu then pressing **ENTER**.

**2**  Select the disc.  
Use **↑/↓** to select, then press **ENTER**.

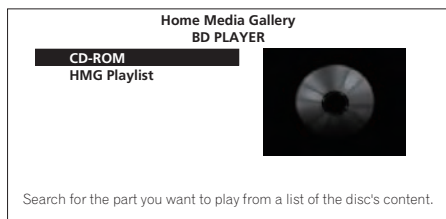

**3**  Select **Music**.  
Use **↑/↓** to select **Music**, then press **ENTER**.

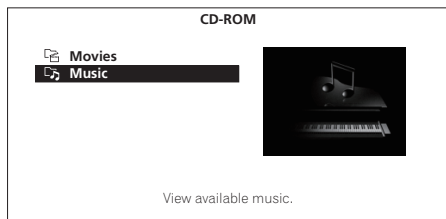

**4**  Select **Folders** or **All Songs**.  
Use **↑/↓** to select, then press **ENTER**.

- **Folders** – The files in the selected folder are displayed.

- **All Songs** – All the recorded files are displayed.

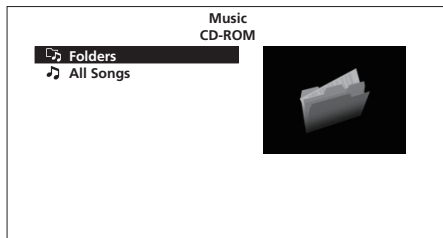

If you have selected **All Songs**, proceed to step 6.

**5**  Select the folder containing the file you want to play.  
Use **↑/↓** to select, then press **ENTER**.

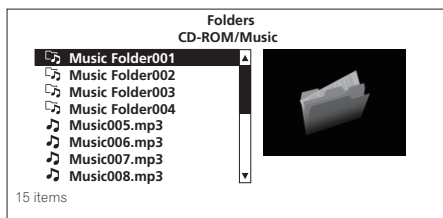

A list of the files and/or the sub-folders in the selected folder is displayed.

**6**  Select and set the file you want to play.  
Use **↑/↓** to select, then press **ENTER**.

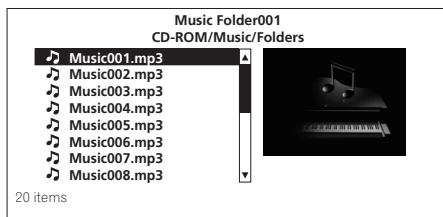

Playback starts. The Now Playing screen (shown below) is displayed.

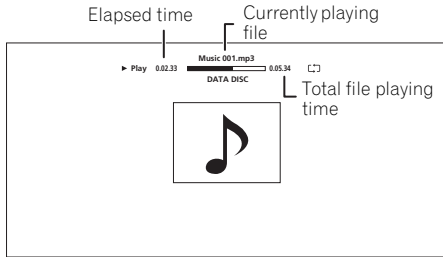

## Playing in the desired order (HMG Playlist)

The discs that can add tracks and files to the HMG (Home Media Gallery) Playlist are as shown below.

- Music CDs (CD-DAs and DTS-CDs)
- DVDs/CDs on which music files are recorded

## Adding tracks/files

Use this procedure to add tracks and files, and create the HMG Playlist.

- 
**Press HOME MEDIA GALLERY to display the Home Media Gallery.**  
 The Home Media Gallery can also be displayed by selecting **Home Media Gallery** from Home Menu pressing **ENTER**.

- 
**Select the disc.**  
 Load the disc beforehand.

Use **↑/↓** to select, then press **ENTER**.

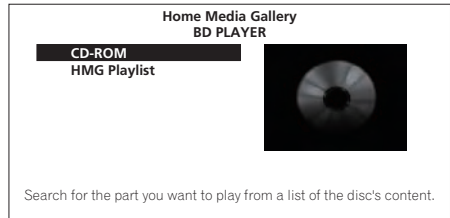

- 
**Select the track/file to be added.**  
 Use **↑/↓** to select.

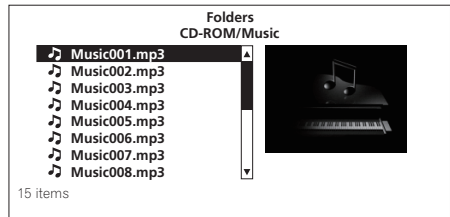

- 
**Press TOOLS to display the TOOLS menu.**

- 
**Select Add to HMG Playlist.**  
 Use **↑/↓** to select, then press **ENTER**.

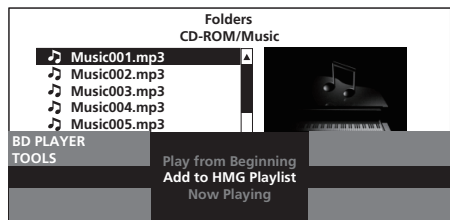

The track or file selected in step 3 is added to the HMG Playlist.  
 To add more tracks or files, repeat steps 3 to 5.

### To add the currently playing track/file to the HMG Playlist



- While the track/file is playing, press **TOOLS** to display the **TOOLS** menu.



- Use **↑/↓** to select **Add to HMG Playlist**, then press **ENTER**.



#### Note

- A maximum of 24 tracks/files can be added to the HMG Playlist.
- The HMG Playlist is cleared in the following cases:
  - When the power is turned off.
  - When the disc tray is opened.

### Playing the HMG Playlist



- 1 Press **HOME MEDIA GALLERY** to display the **Home Media Gallery**.

The Home Media Gallery can also be displayed by selecting **Home Media Gallery** from Home Menu pressing **ENTER**.



- 2 Select **HMG Playlist**. Use **↑/↓** to select, then press **ENTER**.

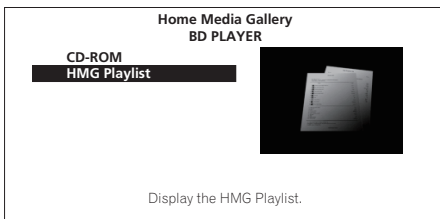

- 3 Select the track/file to be played. Use **↑/↓** to select, then press **ENTER**.

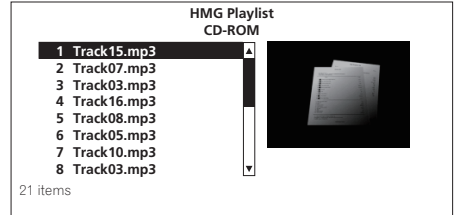

Playback starts. The Now Playing screen (shown below) is displayed.

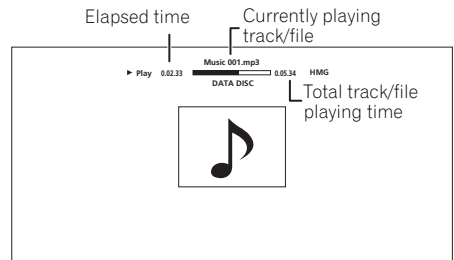

Press **■** (stop) to stop playback. When playback of a music CD is stopped, the Now Playing screen turns off. When playback of a music file is stopped, the HMG Playlist screen reappears.

### Deleting tracks/files from the HMG Playlist



- Select the track/file to be deleted, then press **TOOLS** to display the **TOOLS** menu.



- Use **↑/↓** to select **Delete** from HMG Playlist, then press **ENTER**.



## Chapter 5

# Adjusting audio and video



### Important

- Set the remote control operation selector switch to **BD** to operate the Blu-ray disc player.



## Adjusting the video

The quality of the playback picture can be adjusted according to the TV you are using.



- 1 TOOLS Display the TOOLS menu.**  
During playback, press **TOOLS**.



- 2 Select and set the item.**  
Use **↑/↓** to select **Video Adjust**, then press **ENTER**.



- 3 Select a preset.**  
Select using **←/→** according to the TV being used.



- **LCD** – Select this when connected to a liquid crystal display TV.
- **PDP** – Select this when connected to a plasma TV of another brand.
- **Pioneer PDP** – Select this when connected to a Pioneer plasma TV.

- **Projector** – Select this when connected to a front projector.
- **Professional** – With this setting, video signal processing is restrained. Select this when connected to a professional monitor.
- **Memory1 to 3** – Picture quality settings with adjusted parameters can be stored in the memory. For a description of the parameters, see *When Memory1, 2 or 3 is selected* below.

### When Memory1, 2 or 3 is selected



- 1 Select Adjustments.**  
Use **↓** to select **Adjustments**, then press **ENTER**.

A detailed settings screen appears.



- 2 Select the item to be adjusted.**  
Use **↑/↓** to select.

**Video Adjust [ Memory1 ]**

Prog. Motion	: Motion	: [Progressive Scan Icon]	: [Still Icon]
Pure Cinema	: <	Auto1	>
YNR	: Off	[Progressive Scan Icon]	Max
CNR	: Off	[Progressive Scan Icon]	Max
BNR	: Off	[Progressive Scan Icon]	Max
MNR	: Off	[Progressive Scan Icon]	Max

1/2 Page

Use [ ← ] [ ] [ → ] to adjust the picture to progressive scan.



### 3 Adjust the picture quality.

When are pressed, the adjustments can be made watching the picture. The detailed settings screen reappears when **ENTER** is pressed.



- **Prog.Motion** – Adjust according to the type of image (movie or still image). This is effective when outputting video materials as progressive images.
- **Pure Cinema** – This setting optimizes the operation of the progressive scanning circuit for playing film materials. Normally set it to **Auto1**. If the picture seems unnatural, switch this to **Auto 2**, **On** or **Off** (page 106).
- **YNR** – Reduces noise in the luminance (Y) signal.
- **CNR** – Reduces noise in the chroma (C) signal.
- **BNR** – Reduces the block noise (block-shaped distortion generated upon MPEG compression).
- **MNR** – Reduces the mosquito noise (distortion along the contours of the picture generated upon MPEG compression).
- **Detail** – Emphasizes the picture's contours.
- **White Level** – Adjusts the level of the white portions.
- **Black Level** – Adjusts the level of the black portions.
- **Black Setup** – Select the black level as the setup level. Normally select **0 IRE**. If the black is too dense and all the dark colors are displayed in a uniform black due to the combination with the connected monitor, select **7.5 IRE**.

- **Gamma Correction** – Adjusts how the dark portions of the picture look.
- **Hue** – Adjusts the balance between green and red.
- **Chroma Level** – Adjusts the density of the colors.



#### Note

- **Prog.Motion** and **Pure Cinema** have the effect only for pictures recorded in the interlaced scan format (576i/480i or 1080i signals).
- **Prog.Motion** is disabled when **Pure Cinema** is set to **On**.
- **Black Setup** have the effect only for pictures output from the **VIDEO** and **S-VIDEO** output terminals, and for NTSC signals output.
- **YNR**, **CNR**, **BNR** and **MNR** are disabled when 1080/24p signals are output from the **HDMI OUT** terminal.

### Closing the Video Adjust screen

- Press **HOME MENU**.

### About Pure Cinema

There are two types of video signals:

- **Video material** – Video signals recorded at 25 or 30 frames/second
- **Film material** – Video signals recorded at 24 frames/second

“Pure Cinema” uses signal processing suited for “film material” when converting 576i/480i or 1080i interlaced video signals into progressive video signals, resulting in clear picture reproduction without losing the quality of the material.



is displayed on the disc information screen when playing the “film material” pictures of DVD-Video discs (page 95).

## Adjusting the Audio DRC

Audio DRC (Dynamic Range Control) has the effect of playing loud sounds softly and soft sounds loudly. Adjust the setting for example when watching movies late at night and the dialogs are difficult to hear.



**1** During playback, display the **TOOLS** menu.



**2** Select and set **Audio DRC**.  
Use **↑/↓** to select, then press **ENTER**.

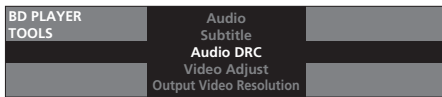

**3** Adjust the setting.  
Use **←/→** to switch between **Off**, **Low**, **Medium**, **High** and **Auto**.



- Audio DRC affects the audio signals output from the following audio output terminals:
  - Analog audio signals output from the **AUDIO OUT (2 ch)** or **AUDIO OUT (7.1 ch)** terminals.
  - Linear PCM audio signals output from the **DIGITAL OUT** terminals or **HDMI OUT** terminal.
- The effect may be weak for some discs.

## Closing the Audio DRC screen

- Press **ENTER** or **HOME MENU**.



### Note

- This only affects the Dolby TrueHD, Dolby Digital Plus and Dolby Digital audio signals of BDs, DVDs and movie files.
- When **Auto** is selected, the setting has the same effect as **High** or **Off** for Dolby TrueHD signals, depending on the content. For Dolby Digital Plus and Dolby Digital, the setting has the same effect as **Off**.

## Chapter 6

## Advanced settings

**Important**

- Set the remote control operation selector switch to **BD** to operate the Blu-ray disc player.



## Changing the settings (Initial Setup)

### Operating the Initial Setup screen



- When playback is stopped, display the Home Menu screen.  
Press **HOME MENU**.

**Note**

- Items that cannot be changed are indicated in gray. The items that can be selected depend on the player's status.
- The factory default settings are indicated in bold.

Setting	Options	Explanation
<b>Video Out</b>		
TV Aspect Ratio	<b>16:9 (Widescreen)</b>	Select this when connected to a wide (16:9) TV.
	4:3 (Standard)	Select this when connected to a conventional TV.
4:3 Video Out	<b>Full</b>	4:3 pictures are displayed over the entire screen.
	Normal	4:3 pictures are displayed with black bands along the sides. Select this when you cannot switch the aspect ratio to 4:3 on the TV.



- Select and set Initial Setup.  
Use **↑/↓** to select, then press **ENTER**.

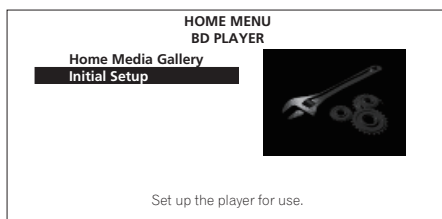

- Select the item and change the setting.  
Use **↑/↓/←/→** to select, then press **ENTER**.

### Closing the Initial Setup screen

- Press **HOME MENU**.

Setting	Options	Explanation
DVD 16:9 Video Out	<b>Letter Box</b>	16:9 pictures are displayed with black bands at the top and bottom when watching on a 4:3 screen.
	Pan & Scan	The picture is displayed over the entire screen, with the left and right sides of the 16:9 picture cut off. Select this to watch 4:3 pictures over the entire screen.
NTSC on PAL TV	<b>On</b>	Select this when connected to the PAL-only TV. When playing the materials with the frame/field rate other than 50 Hz, the PAL-only TV can display correctly.
	Off	Select this when multi-system (NTSC-compatible) TV.
Many recent PAL TVs support the input of NTSC signals. Therefore, this can be set to <b>Off</b> . Check also the operating instructions of your TV.		
Still Picture	Field	This eliminates instability of the picture when playback is paused.
	Frame	This makes pictures clear when playback is paused, but instability may be observed.
	<b>Auto</b>	<b>Field</b> or <b>Frame</b> is selected automatically according to the disc or file being played.
<b>Audio Out</b>		
Dolby Digital Out * Only valid for digital audio outputs.	<b>Dolby Digital 1</b>	Dolby Digital audio signals are output. With BD-ROMs, the secondary audio and interactive audio are mixed for output.
	Dolby Digital 2	Dolby Digital audio signals are output. With BD-ROMs, the signals are output without mixing the secondary audio and interactive audio signals.
	Dolby Digital → PCM	Select this when the connected AV receiver or amplifier, etc., is not compatible with Dolby Digital audio signals. The Dolby Digital audio signals are converted into linear PCM audio signals for output.
DTS Out * Only valid for digital audio outputs.	<b>DTS 1</b>	DTS Digital Surround audio signals are output. With BD-ROMs, the secondary audio and interactive audio are mixed for output.
	DTS 2	DTS Digital Surround audio signals are output. With BD-ROMs, the signals are output without mixing the secondary audio and interactive audio signals.
	DTS → PCM	Select this when the connected AV receiver or amplifier, etc., is not compatible with DTS Digital Surround audio signals. The DTS Digital Surround audio signals are converted into linear PCM audio signals for output.

Setting	Options	Explanation
AAC Out * Only valid for digital audio outputs.	AAC	Select this when the connected AV receiver or amplifier, etc., is compatible with AAC audio signals. The AAC audio signals are output.
	<b>AAC → PCM</b>	Select this when the connected AV receiver or amplifier, etc., is not compatible with AAC audio signals. The AAC audio signals are converted into linear PCM audio signals for output.
DTS Downmix	<b>Stereo</b>	DTS-HD Master Audio signals, DTS-HD High Resolution Audio signals or DTS Digital Surround audio signals converted to linear PCM audio signals are converted into 2-channel (stereo) signals for output.
	Lt/Rt	DTS-HD Master Audio signals, DTS-HD High Resolution Audio signals or DTS Digital Surround audio signals converted to linear PCM audio signals are converted into 2-channel signals compatible with Dolby Surround for output (when the connected AV receiver or amplifier, etc., is compatible with Dolby Pro Logic, the AV receiver or amplifier outputs the linear PCM audio signals as surround audio signals).
<b>Speakers</b>		
Audio Output Mode * Only valid for analog audio outputs.	<b>2 Channel</b>	Select this when the TV's analog 2-channel (stereo) audio input terminals are connected to the player's <b>AUDIO OUT (2 ch)</b> terminals.
	Multi-channel	Select this when the multi-channel audio input terminals of an AV receiver or amplifier, etc., are connected to the player's <b>AUDIO OUT (7.1 ch)</b> terminals.
Speaker Setup * Only valid for analog audio outputs.	When an AV receiver or amplifier, etc., is connected to the player's <b>AUDIO OUT (7.1 ch)</b> terminals, this sets whether or not to use the speakers which are connected to the AV receiver or amplifier, as well as the size of the speakers. For details, see <i>Changing the speaker setup</i> on page 114.	
Channel Level * Only valid for analog audio outputs.	<b>Fix</b>	The output for the various speakers is set to the maximum.
	Variable	The output level of the various speakers is set within the range of -6.0 dB to +6.0 dB (in 0.5 dB steps) (page 115).
<b>HDMI</b>		
HDMI High-Speed Transmission	On	Select this when connected with a High Speed HDMI™ cable (page 77).
	<b>Off</b>	Select this when connected with a Standard HDMI™ cable (page 77).

The player's setting screen is closed if the output video resolution is switched by changing the **HDMI High-Speed Transmission** setting.

When **HDMI High-Speed Transmission** is set to **On**, use the supplied HDMI cable.

Setting	Options	Explanation
HDMI Color Space	<b>Auto</b>	The video signal that is output (YCbCr or RGB) is switched automatically.
	YCbCr 4:4:4	Select this to output the video signals as YCbCr 4:4:4 signals.
	YCbCr 4:2:2	Select this to output the video signals as YCbCr 4:2:2 signals.
	RGB (16 to 235)	Select this to output the video signals as RGB signals. Choose this if the colors seem too dense and all the dark colors are displayed in a uniform black when RGB (0 to 255) is selected.
	RGB (0 to 255)	Select this to output the video signals as RGB signals. Choose this if the colors seem too faint and the black seems too bright when RGB (16 to 235) is selected.
Normally it is recommended to set this to <b>Auto</b> . When set to <b>Auto</b> , the optimum video signals for your TV are output.		
HDMI Audio Out	<b>Auto</b>	The signals are output with as many audio channels as possible. In cases when the number of channels does not decrease when the signals are output as such without converting them to linear PCM, they are output as such (page 121).
	PCM	Select this when you want the secondary audio and interactive audio signals to be mixed for output or when you want to output prioritizing sampling frequency over the number of channels (page 121).
PQLS	<b>Auto</b>	Enables PQLS function (page 78).
	Off	Disables PQLS function (page 78).
HDMI Control	<b>On</b>	Select this to control the player with the remote control of the AV device connected using an HDMI cable. Also refer to <i>About HDMI Control function</i> on page 78.
	Off	Select this when you do not want to control the player with the remote control of the AV device connected using an HDMI cable.
<b>Language</b>		
OSD Language	<b>English</b>	Select this to set the language of the on-screen displays to English.
	<i>available languages</i>	Choose a language for the on-screen displays from the listed languages.

Setting	Options	Explanation
Audio Language * For some discs, it may not be possible to change to the selected language.	<b>English</b>	Select this to set both the BD-ROM and DVD-Video default audio language to English.
	<i>available languages</i>	Choose a language from the listed languages to set the default audio language for BD-ROM and DVD-Video playback.
	Other	Continue to the next screen to set the default audio language for BD-ROM and DVD-Video playback. You can select the language name or enter the code number (see on page 130 for the code table). If a language not recorded on the BD/DVD is set, one of the recorded languages is automatically selected and played.
Subtitle Language * For some discs, it may not be possible to change to the selected language.	<b>English</b>	Select this to set the default subtitle language for BD-ROM and DVD-Video playback to English.
	<i>available languages</i>	Choose a language from the listed languages to set the default subtitle language for BD-ROM and DVD-Video playback.
	Other	Continue to the next screen to set the default subtitle language for BD-ROM and DVD-Video playback. You can select the language name or enter the code number (see on page 130 for the code table). If a language not recorded on the BD/DVD is set, one of the recorded languages is automatically selected and played.
BDMV/DVD-Video Menu Lang. * For some discs, it may not be possible to change to the selected language.	<b>w/Subtitle Language</b>	Sets the language of BD-ROM and DVD-Video menus to the same as that set for the subtitle language.
	<i>available languages</i>	Choose a language from the listed languages to set the default language for BD-ROM and DVD-Video menus.
	Other	Continue to the next screen to set the default menu language for BD-ROM and DVD-Video menus. You can select the language name or enter the code number (see on page 130 for the code table). If a language not recorded on the BD/DVD is set, one of the recorded languages is automatically selected and played.
Subtitle Display	<b>On</b>	Select this to display the subtitles.
	Off	Select this if you do not want to display the subtitles. Note that on some discs the subtitles are displayed by force.
<b>Parental Lock</b>		
Set Password (Change Password)	Register (change) the password for parental lock settings or for unlocking to play DVD-Video with parental lock feature. For details, see <i>Registering or Changing the password</i> on page 116.	
DVD-Video Parental Lock	Change the player's parental lock level. For details, see <i>Changing the Parental Lock level for watching DVDs</i> on page 117.	
BDMV Parental Lock	Change the restricted age. For details, see <i>Changing the Age Restriction for watching BD-ROMs</i> on page 117.	



Setting	Options	Explanation
Country Code		Change the Country/Area code. Refer to the <i>Changing the Country/Area code</i> on page 119.
<b>Options</b>		
Output Terminal Priority		Select the terminals for outputting video and audio signals with priority. For details, see <i>Changing the terminals for outputting video and audio signals (Output Terminal Priority)</i> on page 119.
On Screen Display	<b>On</b>	Select this to display the operation indicators (Play, Stop, etc.) on the TV screen.
	Off	Select this if you do not want to display the operation indicators (Play, Stop, etc.) on the TV screen.
Angle/Secondary Indicator	<b>On</b>	Select this to display the angle mark, secondary video mark and secondary audio mark on the TV screen (pages 92 and 94).
	Off	Select this if you do not want to display the angle mark, secondary video mark and secondary audio mark on the TV screen.
Hybrid Disc Playback	<b>BD</b>	The BD layer of hybrid discs with two or more layers (BD and DVD or CD) is played.
	DVD	The DVD layer of hybrid discs with two or more layers (BD and DVD) is played. If there is no DVD layer, the BD layer is played.
	CD	The CD layer of hybrid discs with two or more layers (BD and CD) is played. If there is no CD layer, the BD layer is played.
BDMV/BDAV Playback Priority	<b>BDMV</b>	Select this to play the BDMV format on BD-R/-RE discs containing both BDMV and BDAV formats.
	<b>BDAV</b>	Select this to play the BDAV format on BD-R/-RE discs containing both BDMV and BDAV formats.
DivX VOD	Registration Code	Displays the player's registration code required to play DivX VOD files (page 75).
Auto Power Off	<b>On</b>	Select this to turn the power off automatically (the power turns off automatically if no operation is performed for over 30 minutes).
	Off	Select this if you do not want the power to turn off automatically.
Setup Navigator		Start making the settings using the Setup Navigator menu. For details, see <i>Important</i> on page 83.

## Changing to other language at language setting

### Note

- Refer to *Language Code Table* on page 130.
- If a language not recorded on the BD/DVD is set, one of the recorded languages is automatically selected and played.



### 1 Select and set Other.

Use  $\uparrow/\downarrow$  to select, then press **ENTER**.



### 2 Change the language.

Use  $\leftarrow/\rightarrow$  to change, then press **ENTER**.

## To change the language using numbers



### 1 Use $\uparrow/\downarrow$ to select Number.



### 2 Use the number buttons (0 to 9) to input the number, then press **ENTER**.

## Changing the speaker setup

Set whether or not to use the speakers which are connected to the AV receiver or amplifier, as well as the size of the speakers. This setting is only valid for analog audio outputs.

### Note

- Select **Initial Setup** from the HOME MENU, then press **ENTER**.



### 1 Select and set Speakers.

Use  $\uparrow/\downarrow$  to select, then press **ENTER**.

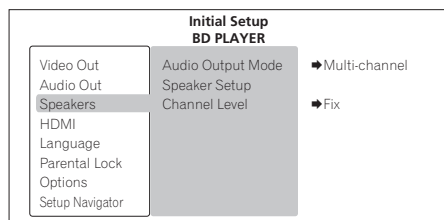

### 2 Select and set Speaker Setup → Next Screen.

Use  $\uparrow/\downarrow$  to select, then press **ENTER**.

### Caution

- This cannot be selected when **Audio Output Mode** is set to **2 Channel**. Change the setting to **Multi-channel** (page 110).



### 3 Select the speaker and change the setting.

Use  $\uparrow/\downarrow$  to select, then use  $\leftarrow/\rightarrow$  to change the setting.

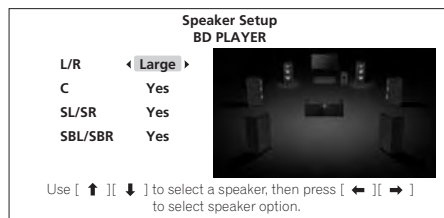

- **L/R** (front left and right speakers): **Small/ Large** (this setting also applies to the C, SL/SR and SBL/SBR speakers)
- **C** (center speaker): **Yes/No**

- **SL/SR** (left and right surround speakers): **Yes/No**
- **SBL/SBR** (left and right surround back speakers): **Yes/No**

## Closing the speaker settings screen

- Press **ENTER**.

## Adjusting the output level of the various speakers (Channel Level)

Adjust each output level of the different speakers by using test tones. This setting is only valid for analog audio outputs.



- 1 **Select and set Speakers.**  
Use **↑/↓** to select, then press **ENTER**.

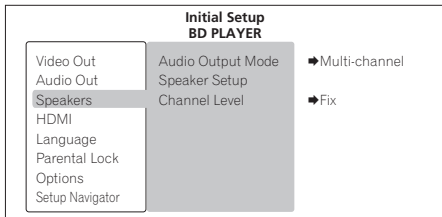

- 2 **Select and set Channel Level, then Fix or Variable.**

Use **↑/↓** to select, then press **ENTER**.

- **Fix** – The output level of all the speakers is set to the maximum.
- **Variable** – The output level of all the speakers is set 6.0 dB lower than when **Fix** is selected. From this point, the output levels of the **L**, **C**, **R**, **SL**, **SR**, **SBL**, **SBR** and **SW** speakers can be adjusted within the range of **-6.0 dB** to **+6.0 dB**.
- If you have selected **Variable**, proceed to step 3.



### Caution

- This cannot be selected when **Audio Output Mode** is set to **2 Channel**. Change the setting to **Multi-channel** (page 110).



- 3 **Select and set the method for switching the speaker to be adjusted.**  
Use **←/→** to select, then press **ENTER**.

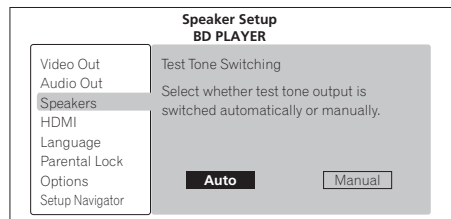

- **Auto** – Switch the speaker to be adjusted automatically.
- **Manual** – Switch the speaker to be adjusted manually.



### Caution

- Test tones are output. Lower the volume of the device connected to the player.



- 4 **Adjust the output level.**  
Use **↑/↓** to select, **←/→** to adjust.

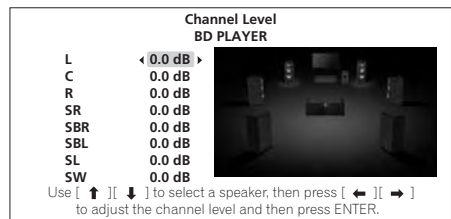

**Note**

- When **Auto** is selected, the speaker cannot be selected with **↑/↓**.

**Closing the Channel Level screen**

- Press **ENTER**.

**Registering or Changing the password**

Use this procedure to register or change the code number required for the Parental Lock settings.

**1 Select and set Parental Lock.**

Use **↑/↓** to select, then press **ENTER**.

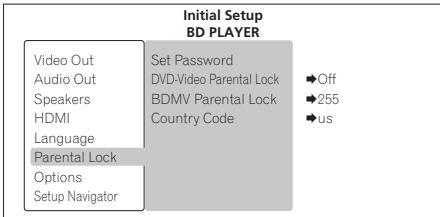
**2 Select and set Set Password → Next Screen.**

Use **↑/↓** to select, then press **ENTER**.

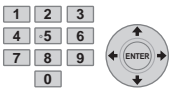
**3 Input the password.**

Use the number buttons (0 to 9) or **↑/↓** to input the number, then press **ENTER** to set.

Use **←/→** to move the cursor.

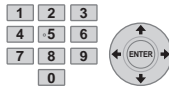
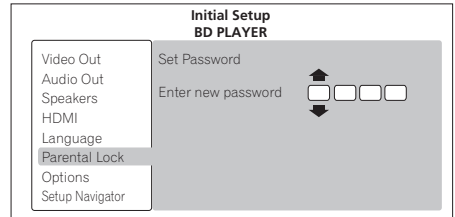
**4 Re-input the password.**

Use the number buttons (0 to 9) or **↑/↓** to input the number, then press **ENTER** to set.

Use **←/→** to move the cursor.

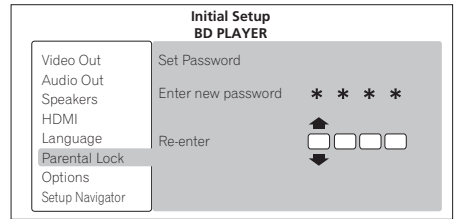
**To change the code number**

Input the previously registered password, then input the new password.



**Note**

- We recommend making a note of the password.
- If you forget the password, reset the player to the factory default setting, then register the password again (page 120).



## Changing the Age Restriction for watching BD-ROMs



For BD-ROMs containing scenes of violence, for example, watching can be restricted by setting an age restriction for the BD-ROMs.

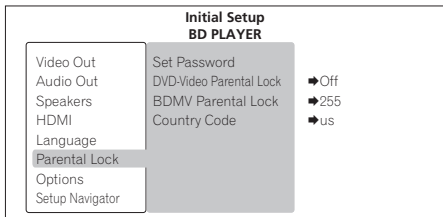



**1**  **Select and set Parental Lock.**  
Use  to select, then press **ENTER**.

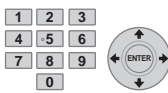

**2**  **Select and set BDMV Parental Lock → Next Screen.**  
Use  to select, then press **ENTER**.

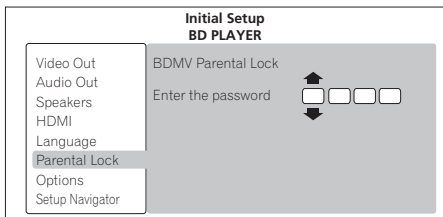
**3**  **Input the password.**  
Use the number buttons (0 to 9) or  to input the number, then press **ENTER** to set.  
Use  to move the cursor.

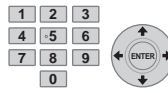

**4**  **Change the age.**  
Use the number buttons (0 to 9) or  to input the number, then press **ENTER** to set.  
Use  to move the cursor.

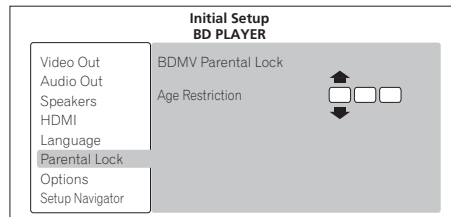

 **Note**

- When **Age Restriction** is set to **255**, watching is not restricted.

## Changing the Parental Lock level for watching DVDs

Some DVD-Video discs containing scenes of violence, for example, have Parental Lock levels (check the indications on the disc's jacket or elsewhere). To restrict watching these discs, set the player's level to the level lower than the discs.





### 1 Select and set Parental Lock.

Use **↑/↓** to select, then press **ENTER**.

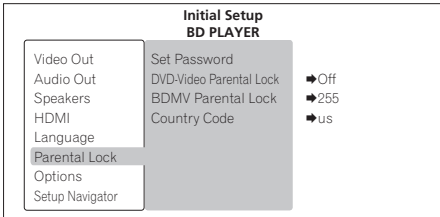

### 4 Change the level.

Use **←/→** to change, then press **ENTER** to set.

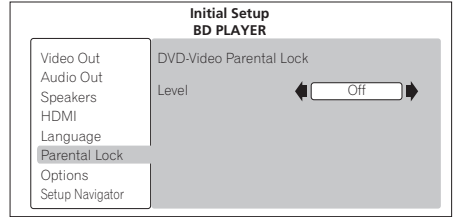

### 2 Select and set DVD-Video Parental Lock → Next Screen.

Use **↑/↓** to select, then press **ENTER**.

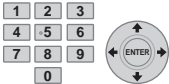

### 3 Input the password.

Use the number buttons (0 to 9) or **↑/↓** to input the number, then press **ENTER** to set.

Use **←/→** to move the cursor.

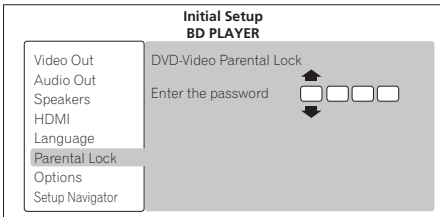

### Note

- The level can be set to **Off** or between **Level1** and **Level8**. When set to **Off**, watching is not restricted.

## Changing the Country/Area code



### Note

- Refer to *Country/Area Code Table* on page 131.



- Select and set Parental Lock.**  
Use  $\uparrow/\downarrow$  to select, then press **ENTER**.

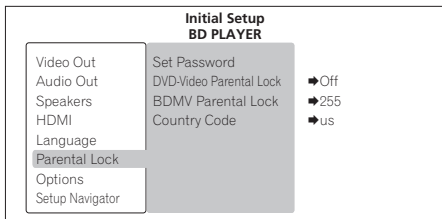

- Select and set Country/Area Code.**  
Use  $\uparrow/\downarrow$  to select, then press **ENTER**.

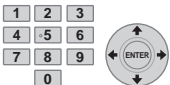

- Input the password.**  
Use the number buttons (0 to 9) or  $\uparrow/\downarrow$  to input the number, then press **ENTER** to set.  
Use  $\leftarrow/\rightarrow$  to move the cursor.

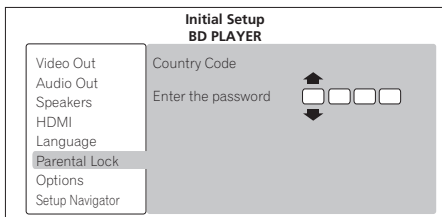

- Change the country/area code.**  
Use  $\leftarrow/\rightarrow$  to change, then press **ENTER** to set.

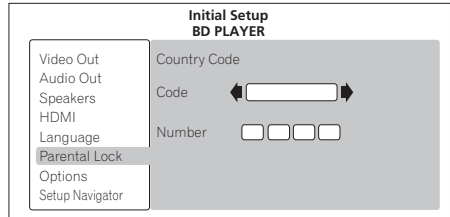

## To change the country/area code using numbers



- Use  $\uparrow/\downarrow$  to select **Number**.



- Use the number buttons (0 to 9) to input the number, then press **ENTER**.

## Changing the terminals for outputting video and audio signals (Output Terminal Priority)

Set the video and audio terminals to be used.



- Select and set Options.**  
Use  $\uparrow/\downarrow$  to select, then press **ENTER**.

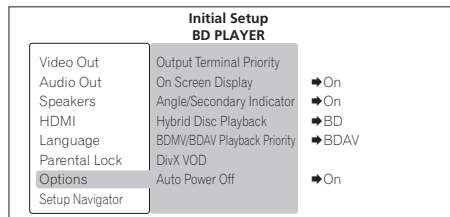



## 2 Select and set Output Terminal Priority → Next Screen.

Use **↑/↓** to select, then press **ENTER**.



## 3 Select the terminal for outputting video signals.

Use **←/→** to select, then press **↓**.

When a digital output is selected for the video output terminal, **Video** is fixed at **HDMI** and cannot be changed.

When an analog output is selected for the video output terminal, **Component Video** or **S-Video/Video** can be selected for **Video**.

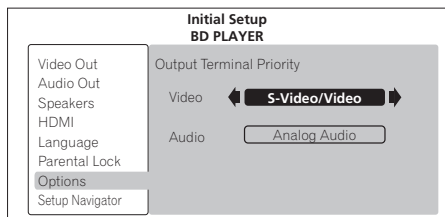

- **HDMI – HDMI OUT** terminal
- **Component Video – COMPONENT VIDEO** output terminals
- **S-Video/Video – S-VIDEO** output terminal or **VIDEO** output terminal

The video and audio signals output from the set output terminals are output synchronously (lip synchronization).



### Caution

- If the output terminal you want to select at **Video** is not displayed, use the **VIDEO SELECT** button to switch between digital and analog output (page 87).



## 4 Select the terminal for outputting audio signals.

Use **←/→** to select, then press **ENTER**.

- **HDMI – HDMI OUT** terminal
- **Digital Audio – DIGITAL OUT (OPTICAL)** terminal
- **Analog Audio – AUDIO OUT (2 ch)** terminals or **AUDIO OUT (7.1 ch)** terminals

The optimum audio signals for the audio format and the player's settings are output from the output terminal(s) set here.



### Caution

- Linear PCM (2-channel) audio signals are output from the audio terminals other than the one set at **Audio**, regardless of the audio format and the player's settings.

## Restoring all the settings to the factory default settings

**1 Check that the player's power is turned on.**

**2 When a disc is playing, press ■ STOP to stop playback.**

Eject the disc from the player.

**3 While pressing ■ STOP, press ⏻ STANDBY/ON.**

Operate using the buttons on the player's front panel.



### Note

- After restoring all the settings to the factory default settings, use Setup Navigator to reset the player (page 83).



## About the audio output settings

The audio signals that are output differ according to the audio format recorded on the disc and the player's settings. Check on the table below.

Audio format	AUDIO OUT terminal		DIGITAL OUT terminal		HDMI OUT terminal <sup>1</sup>	
	2ch <sup>2</sup>	Multi-channel <sup>2</sup>	Converted to linear PCM audio <sup>3</sup>	Not converted to linear PCM audio <sup>4,5</sup>	PCM <sup>6</sup>	Auto <sup>6,7,8</sup>
BD-ROM	Dolby Digital	5.1-channel audio			5.1-channel audio	Dolby Digital
	Dolby Digital Plus			Dolby Digital	7.1-channel audio <sup>9,10</sup>	Dolby Digital Plus
	Dolby TrueHD					Dolby TrueHD <sup>11</sup>
	DTS Digital Surround	Converted to 2-channel audio	5.1-channel audio	Converted to 2-channel audio	5.1-channel audio	DTS Digital Surround
	DTS-HD High Resolution Audio		5.1-channel audio		DTS Digital Surround	DTS-HD High Resolution Audio
	DTS-HD Master Audio		5.1-channel audio <sup>12</sup>		5.1-channel audio <sup>12</sup>	DTS-HD Master Audio <sup>13</sup>
	Linear PCM		7.1-channel audio <sup>9</sup>		Converted to 2-channel audio	7.1-channel audio <sup>9,10</sup>
BD-R/RE	Dolby Digital	Converted to 2-channel audio	5.1-channel audio	Converted to 2-channel audio	Dolby Digital	5.1-channel audio
	MPEG-2 AAC			MPEG-2 AAC		Dolby Digital
	MPEG					MPEG-2 AAC
	Linear PCM			2-channel audio		
DVD-Video	Dolby Digital	Converted to 2-channel audio	5.1-channel audio	Converted to 2-channel audio	Dolby Digital	5.1-channel audio
	DTS Digital Surround			DTS Digital Surround		DTS Digital Surround
	MPEG					2-channel audio
	Linear PCM					2-channel audio
DVD (VR format)	Dolby Digital	Converted to 2-channel audio	5.1-channel audio	Converted to 2-channel audio	Dolby Digital	5.1-channel audio
	MPEG					Dolby Digital
	Linear PCM			2-channel audio		

1. When outputting linear PCM audio signals, if the number of compatible channels of the connected HDMI device is lower, the signals are output with the number of channels for which the device is compatible.
2. When **Audio Output Mode** is set to **2 Channel** or **Multi-channel** (page 110).
3. When **Dolby Digital Out** is set to **Dolby Digital** → **PCM**, **DTS Out** is set to **DTS** → **PCM**, or **AAC Out** is set to **AAC** → **PCM** (page 109).
4. When **Dolby Digital Out** is set to **Dolby Digital 1/Dolby Digital 2**, **DTS Out** is set to **DTS 1/DTS 2** or **AAC Out** is set to **AAC** (page 109).
5. When outputting Dolby Digital or DTS Digital Surround bitstream with settings of **Dolby Digital 2** at **Dolby Digital Out**, **DTS 2** at **DTS Out**, the secondary audio and interactive audio signals are not mixed for output.
6. When **HDMI Audio Out** is set to **PCM** or **Auto** (page 111).
7. When outputting the bitstream of Dolby TrueHD, Dolby Digital Plus, Dolby Digital, DTS-HD Master Audio, DTS-HD High Resolution Audio or DTS Digital Surround, the secondary audio and interactive audio signals are not mixed.

8. If the connected HDMI device is not compatible with Dolby TrueHD or Dolby Digital Plus bitstream, the signals are output in Dolby Digital bitstream.  
If the connected HDMI device is not compatible with DTS-HD Master Audio or DTS-HD High Resolution Audio, the signals are output in DTS Digital Surround bitstream.  
If the connected HDMI device is not compatible with Dolby Digital or DTS Digital Surround bitstream, the signals are output in linear PCM.
9. Only compatible with 7.1-channel surround back. 6.1-channel surround back is output in 7.1 channels. In other cases, output as audio signals of 5.1-channels or less.
10. When the output video resolution is set to 576i/480i or 576p/480p, the signals may be output in 2 channel, depending on **HDMI High-Speed Transmission** setting and/or the connected HDMI device (page 77).
11. When the output video resolution is set to 576i/480i or 576p/480p, the signals may be output in Dolby Digital bitstream, depending on **HDMI High-Speed Transmission** setting and/or the connected HDMI device (page 77).
12. DTS Digital Surround signals converted to linear PCM audio signals are output.
13. When the output video resolution is set to 576i/480i or 576p/480p, the signals may be output in DTS Digital Surround bitstream, depending on **HDMI High-Speed Transmission** setting and/or the connected HDMI device (page 77).



### Caution

- Linear PCM audio signals (2 channels) are output from all terminals other than the ones selected at **Audio** under **Output Terminal Priority**, regardless of the audio format or the player's settings (pages 83 and 119).
- The audio signals output from the **DIGITAL OUT** terminals have a sampling frequency of 48 kHz (44.1 kHz for CDs).
- MPEG audio is output in linear PCM.
- When connected to this receiver using the HDMI jacks, the audio signals are converted as below for output from this player.
  - Dolby TrueHD signals are decoded by this player and output as 5.1-channel (or fewer) linear PCM signals.
  - Dolby Digital Plus signals are output as a Dolby Digital bitstream.
  - DTS-HD Master Audio or DTS-HD High Resolution Audio signals are output as a DTS Digital Surround bitstream.
  - MPEG-2 AAC signals are decoded by this player and output as 2-channel linear PCM signals.
  - 7.1-channel linear PCM signals are downmixed to 5.1 channels for output.

## Chapter 7

# Additional information

### Troubleshooting

Incorrect operation is often mistaken for trouble or malfunction. If you think that there is something wrong with this component, check the points below. Sometimes the trouble may lie in another component. Inspect the other components and electrical appliances being used. If the trouble cannot be rectified even after checking the points below, ask your nearest Pioneer authorized service center or your dealer to carry out repair work.

### Playback

Problem	Check	Remedy
Disc does not play. Disc tray opens automatically.	Is the disc scratched?	It may not be possible to play scratched discs.
	Is the disc dirty?	Clean the disc (see the Blu-ray disc player's operating instructions).
	Is the disc properly set in the disc tray?	<ul style="list-style-type: none"> <li>• Set the disc with the printed side facing up.</li> <li>• Set the disc properly in the depression in the disc tray.</li> </ul>
	Is the region number correct?	<p>The region numbers of discs that can be played on this set are as shown below (page 74).</p> <ul style="list-style-type: none"> <li>• BDs: "B" (or including "B") and "ALL"</li> <li>• DVDs: "2" (or including "2") and "ALL"</li> </ul>
	Is the player set in a humid place?	There could be condensation inside. Wait for the condensation to dissipate. Do not set the player near an air-conditioner, etc. (see the Blu-ray disc player's operating instructions).
Picture freezes and the front panel and remote control buttons stop working.		<ul style="list-style-type: none"> <li>• Press <b>■</b> (stop) to stop playback, then restart playback.</li> <li>• If the playback cannot be stopped, press <b>⏻</b> <b>STANDBY/ON</b> on the player's front panel to turn off the power, then turn the power back on.</li> <li>• If the power cannot be turned off, press and hold <b>⏻</b> <b>STANDBY/ON</b> on the player's front panel for over 5 seconds. The power will turn off.</li> </ul>

Problem	Check	Remedy
No picture is displayed or the picture is not displayed properly.	Is the video cable properly connected?	Insert the cable firmly and all the way in.
	Is the video cable damaged?	If the cable is damaged, replace it with a new one.
	Is the input setting on the connected TV or AV receiver or amplifier right?	Read the operating instructions of the connected components and switch to the proper input.
	Are the terminals for outputting video signals properly set?	Press <b>VIDEO SELECT</b> to switch the terminal from which the video signals are output.
	Is the output video resolution properly set?	Depending on the player's output video resolution, the picture may not be displayed at all or displayed properly. Use <b>OUTPUT RESOLUTION</b> to switch to a resolution at which the picture is displayed properly (page 87).
	Is the player connected with an HDMI cable other than a High Speed HDMI™ cable (with a Standard HDMI™ cable)?	Press <b>■ STOP</b> while pressing <b>▶ PLAY</b> on the player's front panel to restore the video outputs to the factory default settings. After this, use the Setup Navigator to reset the player.  There are some BDs for which the picture will only be output when connected by HDMI cable.
Does the connected TV support the frame rate of the video signal being output by the player?	If the picture is not displayed when playing a disc with a frame rate that is not supported, the picture will not be displayed even when playback is stopped. In this case, use the procedure below to switch the frame rate of the video signals output from the player. Eject the disc and close the disc tray. Then, press <b>▲ OPEN/CLOSE</b> while pressing <b>▶ PLAY</b> on the player's front panel to switch to a frame rate supported by the connected TV.	
Is <b>NTSC on PAL TV</b> properly set?	Set <b>NTSC on PAL TV</b> properly (page 109).	
Picture is stretched. Aspect ratio cannot be switched.	Is the TV's aspect ratio properly set?	Read the TV's operating instructions and set the TV's aspect ratio properly.
	Is <b>4:3 Video Out</b> properly set?	<ul style="list-style-type: none"> <li>• Set <b>4:3 Video Out</b> properly (page 108).</li> <li>• When video signals with a resolution of 1080/50i, 1080/50p, 720/50p, 1080/24p, 1080/60i, 1080/60p or 720/60p are being output from the <b>HDMI OUT</b> terminal or the <b>COMPONENT VIDEO</b> output terminals, they may be output with an aspect ratio of 16:9 even if <b>TV Aspect Ratio</b> is set to <b>4:3 (Standard)</b> (page 87).</li> </ul>
Sound and picture are not synchronized.	Is <b>Output Terminal Priority</b> properly set?	Set <b>Output Terminal Priority</b> properly (pages 83 and 119).
Picture is disturbed during playback. Picture is dark.		<ul style="list-style-type: none"> <li>• This player supports Macrovision analog copy protection technology. With some TVs (such as with built-in video deck), the picture will not be displayed properly when the copy protected DVD title is played. This is not a malfunction.</li> <li>• If the player and TV are connected via a DVD recorder/ video deck, etc., the picture will not be displayed properly due to analog copy protection. Connect the player and TV directly.</li> </ul>

Problem	Check	Remedy
No picture is displayed or picture is not output in high definition when playing BDs.		With some content protected discs, it may not be possible to output the video signals from the <b>VIDEO</b> output terminals, the <b>S-VIDEO</b> output terminal or the <b>COMPONENT VIDEO</b> output terminals. In this case, connect using an HDMI cable (page 76).
No sound is output. Sound is disturbed.	Is the disc played back in slow motion? Is the disc played back in fast forward or fast reverse? Is the disc scratched? Is the disc dirty?	No sound is output during slow motion play and forward and reverse scanning.  The sound may not be output if the disc is scratched.  Clean the disc (see the Blu-ray disc player's operating instructions).
	Is the player properly connected to the other components (AV receiver or amplifier, etc.)?	<ul style="list-style-type: none"> <li>• Check that you connect the player to the audio output terminals of a different component, etc.</li> <li>• Check that you connect the player to the PHONO input terminals of the AV receiver or amplifier, etc.</li> </ul>
	Are the audio cables properly connected?	Insert the cables firmly and all the way in.
	Is the audio cable damaged?	If the cable is damaged, replace it with a new one.
	Is <b>Audio Output Mode</b> properly set?	If <b>Audio Output Mode</b> is set to <b>Multi-channel</b> , the audio signals may not be output properly from the <b>AUDIO OUT (2 ch)</b> terminals (page 109). Set <b>Audio Output Mode</b> to <b>2 Channel</b> .
	Are the speakers properly set?	Set <b>Speaker Setup</b> properly (page 110).  For some BDs, audio signals are only output from the <b>DIGITAL OUT (OPTICAL)</b> terminal or the <b>HDMI OUT</b> terminal.

Problem	Check	Remedy
Multi-channel sound is not output.	Is the AV receiver or amplifier, etc. connected to the <b>HDMI OUT</b> terminal, the <b>AUDIO OUT (7.1 ch)</b> terminals or <b>DIGITAL OUT (OPTICAL)</b> terminal?	Read the operating instructions of the connected AV receiver or amplifier and check the audio output settings of AV receiver or amplifier.
	Is <b>Output Terminal Priority</b> properly set?	Linear PCM (2-channel) audio signals are output from output terminals other than the one set at <b>Audio</b> under <b>Output Terminal Priority</b> . Set <b>Output Terminal Priority</b> properly (page 119).
	Is the audio output of the connected AV receiver or amplifier, etc., properly set?	Read the operating instructions of the connected AV receiver or amplifier and check the audio output settings of AV receiver or amplifier.
	Is multi-channel sound selected?	Use the menu screen or <b>AUDIO</b> to switch the disc's sound to multi-channel.
	Is <b>Audio Out</b> set to audio formats supported by the connected AV receiver or amplifier?	<ul style="list-style-type: none"> <li>• Read the operating instructions of the connected AV receiver or amplifier and check the supported audio formats.</li> <li>• Set <b>Audio Out</b> properly (page 109).</li> </ul>
	Are <b>Audio Output Mode</b> and <b>Speaker Setup</b> properly set?	<ul style="list-style-type: none"> <li>• When the AV receiver or amplifier, etc., is connected to the <b>AUDIO OUT (7.1 ch)</b> terminals, set <b>Audio Output Mode</b> to <b>Multi-channel</b> (page 110).</li> <li>• Set <b>Speaker Setup</b> properly (page 110).</li> </ul>
Digital audio signals are not output from the <b>DIGITAL OUT (OPTICAL)</b> terminals (analog audio signals are output).	Is <b>Audio Out</b> set to audio formats supported by the connected AV receiver or amplifier?	<ul style="list-style-type: none"> <li>• Read the operating instructions of the connected AV receiver or amplifier and check the supported audio formats.</li> <li>• Set <b>Audio Out</b> properly (page 109).</li> </ul>
Noise can be heard when outputting DTS Digital Surround signals.	Is the connected AV receiver or amplifier compatible with DTS Digital Surround?	If an AV receiver or amplifier that is not compatible with DTS Digital Surround is connected to the <b>DIGITAL OUT</b> terminal, set <b>DTS Out</b> to <b>DTS → PCM</b> . Noise will be heard if <b>DTS Out</b> is set to <b>DTS</b> (page 109).
192 kHz or 96 kHz digital audio signals cannot be output from the <b>DIGITAL OUT (OPTICAL)</b> terminals.		It is not possible to output 192 kHz or 96 kHz digital audio signals from this player's <b>DIGITAL OUT (OPTICAL)</b> terminals. The signals are automatically converted to under 96 kHz for output.
Secondary audio or interactive audio is not output.	Is <b>HDMI Audio Out</b> properly set?	Set <b>HDMI Audio Out</b> to <b>PCM</b> (page 111).
	Are <b>Dolby Digital Out</b> and <b>DTS Out</b> properly set?	Set <b>Dolby Digital Out</b> to <b>Dolby Digital 1</b> , <b>DTS Out</b> to <b>DTS 1</b> (page 109).
Sound is fast or slow.	When an HDMI cable is connected, are audio signals being output from devices connected with cables other than HDMI cables?	When this player is connected by HDMI cable to a Pioneer AV receiver or amplifier compatible with the PQLS function via HDMI connection, the PQLS function is activated when playing a music CD (CD-DA). Because of this, the sound output from components other than the ones connected by HDMI cable may be fast or slow. If this happens, set <b>PQLS</b> to <b>Off</b> (page 111).

Problem	Check	Remedy
Files recorded on discs cannot be played.	Is the disc one that is playable on this player?	Check whether the disc is one that can be played on this player (page 71).
	Is the file one that is playable on this player?	<ul style="list-style-type: none"> <li>• Check whether the file is one that can be played on this player (page 74).</li> <li>• Check whether or not the file is damaged.</li> </ul>
	Is the file protected by DRM?	Files protected by DRM cannot be played (not including DivX VOD files).
A message indicating low memory (local storage) appears while playing a BD-ROM disc.		Erase the BDMV data (page 87).

## When connected using an HDMI cable

Problem	Check	Remedy
HDMI indicator does not light.	Is the input of the connected HDMI device properly set?	Read the HDMI device's operating instructions and set the input properly.
	Is a DVI device connected?	Read the DVI device's operating instructions and check whether it is compatible with HDCP.
No picture is displayed.	Is the HDMI indicator lit?	<ul style="list-style-type: none"> <li>• If the HDMI indicator is not lit, read the HDMI device's operating instructions and switch to the proper input.</li> <li>• If the HDMI indicator is lit, use <b>OUTPUT RESOLUTION</b> to switch the output video resolution (page 87).</li> </ul>
	Are the terminals for outputting video signals properly set?	Press <b>VIDEO SELECT</b> to switch the <b>HDMI OUT</b> terminal.
	Is the resolution properly set?	Depending on the output video resolution setting, the picture may not be output. Use <b>OUTPUT RESOLUTION</b> to switch the output video resolution (page 87).
	Is the HDMI cable properly connected?	<ul style="list-style-type: none"> <li>• Insert the cable firmly and all the way in.</li> <li>• With some cables, 1080p video signals cannot be properly output.</li> </ul>
	Is a DVI device connected?	The picture may not be displayed properly if a DVI device is connected.
	Is the HDMI cable damaged?	If the cable is damaged, replace it with a new one.
Pictures do not display properly on the TV.		Change the <b>HDMI Color Space</b> setting (page 111).
No sound is produced.	Is a DVI device connected?	The sound will not be output from the <b>HDMI OUT</b> terminal if a DVI device is connected. Connect the device to a <b>DIGITAL OUT (OPTICAL)</b> terminal or the <b>AUDIO OUT (2 ch)</b> terminals.

Problem	Check	Remedy
HDMI Control function does not work.	Is the HDMI cable properly connected?	Connect the HDMI cable properly.
	Is the HDMI cable you are using a High Speed HDMI™ cable?	Use a High Speed HDMI™ cable. The HDMI Control function may not work properly if HDMI cable other than a High Speed HDMI™ cable is used.
	Is <b>HDMI Control</b> set to <b>On</b> on the player?	Set <b>HDMI Control</b> to <b>On</b> on the player (page 111).
	Does the connected device support the HDMI Control function?	<ul style="list-style-type: none"> <li>• The HDMI Control function will not work with devices manufactured by companies other than Pioneer, even when connected using an HDMI cable.</li> <li>• The HDMI Control function will not work if devices that do not support the HDMI Control function or devices manufactured by companies other than Pioneer are connected between the HDMI Control-compatible device and the player.</li> <li>• The HDMI Control function may not work with certain Flat Screen TVs.</li> </ul> Also refer to the operating instructions of the connected device.
	Is HDMI Control set to On on the connected device?	Set HDMI Control to On on the connected device. The HDMI Control function works when HDMI Control is set to On for all the devices connected by HDMI cable. Once connections and settings of all the devices are finished, be sure to check that the player's picture is output to the Flat Screen TV. (Also check after changing the connected devices and connecting and/or disconnecting HDMI cables.) If the player's picture is not being output to the Flat Screen TV, the HDMI Control function may not work properly. For details, refer to the operating instructions of the connected device.
Are multiple players connected?	The HDMI Control function may not work if three or more players, including this player, are connected by HDMI cable.	

## Others

Problem	Check	Remedy
The power turns off automatically.	Is <b>Auto Power Off</b> set to <b>On</b> ?	If <b>Auto Power Off</b> is set to <b>On</b> , the power turns off automatically if no operation is performed for over 30 minutes (page 113).
	Is <b>HDMI Control</b> set to <b>On</b> ?	The player's power may turn off together with the power of the connected TV. If you do not want the player's power to turn off when the TV's power is turned off, set <b>HDMI Control</b> to <b>Off</b> (page 111).
The power turns on automatically.	Is <b>HDMI Control</b> set to <b>On</b> ?	The player's power may turn on together with the power of the connected TV. If you do not want the player's power to turn on when the TV's power is turned on, set <b>HDMI Control</b> to <b>Off</b> (page 111).



Problem	Check	Remedy
Inputs of connected TV and this receiver, switches automatically.	Is <b>HDMI Control</b> set to <b>On</b> ?	The inputs of the connected TV or this receiver may automatically switch to the player when playback starts on the player or the menu screen (Home Media Gallery, etc.) is displayed. If you do not want the inputs of the connected TV and/or this receiver to switch automatically, set <b>HDMI Control to Off</b> (page 111).
Player cannot be operated with remote control.	Is an AV receiver or amplifier connected to the <b>CONTROL IN</b> terminal on the player's rear panel?	Operate with the remote control of the device connected to the <b>CONTROL IN</b> terminal.
	Are you operating the remote control from a point too far away from the player?	Operate from within 7 m of the remote control sensor.
	Are the batteries dead?	Replace the batteries (page 9).
Settings you have made have been cleared.	<ul style="list-style-type: none"> <li>• Have you disconnected the power cord while the player's power was on?</li> <li>• Has there been a power failure?</li> </ul>	If the power cord is disconnected or there is a power failure while the player's power is on, the settings you have made may be cleared. Always press <b>STANDBY/ON</b> on the player's front panel or <b>BD</b> on the remote control and check that <b>POWER OFF</b> has turned off from the player's front panel display before disconnecting the power cord. Be particularly careful when the power cord is connected to the AC outlet on another device because the player turns off in conjunction with the device. We recommend plugging the power cord into a wall outlet whenever possible.
After a disc is inserted, <b>Loading</b> stays displayed and playback does not start.	Are there too many files recorded on the disc?	When a disc on which files are recorded is inserted, depending on the number of files recorded on the disc, loading may take several dozen minutes.
■ is displayed in file names, etc.		The characters that cannot be displayed on this player are displayed in ■.
The DVD layer of BD and DVD hybrid discs cannot be played.	Is <b>Hybrid Disc Playback</b> properly set?	Set <b>Hybrid Disc Playback</b> to <b>DVD</b> (page 113).
The CD layer of BD and CD hybrid discs cannot be played.	Is <b>Hybrid Disc Playback</b> properly set?	Set <b>Hybrid Disc Playback</b> to <b>CD</b> (page 113).
The <b>Hybrid Disc Playback</b> setting cannot be changed (displayed in gray).	Is a disc set in the disc tray?	The <b>Hybrid Disc Playback</b> setting cannot be changed when a disc is set. Remove the disc, then change the setting.
<b>BDMV/BDAV Playback Priority</b> setting cannot be changed (displayed in gray).	Is a disc set in the disc tray?	The <b>BDMV/BDAV Playback Priority</b> setting cannot be changed when a disc is set. Remove the disc, then change the setting.

## Language Code Table and Country/Area Code Table

### Language Code Table

#### Language name (language code), input code

Japanese (ja/jpn), <b>1001</b>	Esperanto (eo/epo), <b>0515</b>	Lingala (ln/lin), <b>1214</b>	Samoan (sm/smo), <b>1913</b>
English (en/eng), <b>0514</b>	Estonian (et/est), <b>0520</b>	Lao (lo/lao), <b>1215</b>	Shona (sn/sna), <b>1914</b>
French (fr/fra), <b>0618</b>	Basque (eu/eus), <b>0521</b>	Lithuanian (lt/lit), <b>1220</b>	Somali (so/som), <b>1915</b>
German (de/deu), <b>0405</b>	Persian (fa/fas), <b>0601</b>	Latvian (lv/lav), <b>1222</b>	Albanian (sq/sqi), <b>1917</b>
Italian (it/ita), <b>0920</b>	Finnish (fi/fin), <b>0609</b>	Malagasy (mg/mlg), <b>1307</b>	Serbian (sr/srp), <b>1918</b>
Spanish (es/spa), <b>0519</b>	Fijian (fj/fij), <b>0610</b>	Maori (mi/mri), <b>1309</b>	Swati (ss/ssw), <b>1919</b>
Chinese (zh/zho), <b>2608</b>	Faroese (fo/fao), <b>0615</b>	Macedonian (mk/mkd), <b>1311</b>	Sotho, Southern (st/sot), <b>1920</b>
Dutch (nl/nld), <b>1412</b>	Frisian (fy/fry), <b>0625</b>	Malayalam (ml/mal), <b>1312</b>	Sundanese (su/sun), <b>1921</b>
Portuguese (pt/por), <b>1620</b>	Irish (ga/gle), <b>0701</b>	Mongolian (mn/mon), <b>1314</b>	Swahili (sw/swa), <b>1923</b>
Swedish (sv/swe), <b>1922</b>	Scots-Gaelic (gd/gla), <b>0704</b>	Moldavian (mo/mol), <b>1315</b>	Tamil (ta/tam), <b>2001</b>
Russian (ru/rus), <b>1821</b>	Galician (gl/glg), <b>0712</b>	Marathi (mr/mar), <b>1318</b>	Telugu (te/tel), <b>2005</b>
Korean (ko/kor), <b>1115</b>	Guarani (gn/grn), <b>0714</b>	Malay (ms/msa), <b>1319</b>	Tajik (tg/tgk), <b>2007</b>
Greek (el/ell), <b>0512</b>	Gujarati (gu/guj), <b>0721</b>	Maltese (mt/mlt), <b>1320</b>	Thai (th/tha), <b>2008</b>
Afar (aa/aar), <b>0101</b>	Hausa (ha/hau), <b>0801</b>	Burmese (my/mya), <b>1325</b>	Tigrinya (ti/tir), <b>2009</b>
Abkhazian (ab/abk), <b>0102</b>	Hindi (hi/hin), <b>0809</b>	Nauru (na/nau), <b>1401</b>	Turkmen (tk/tuk), <b>2011</b>
Afrikaans (af/afz), <b>0106</b>	Croatian (hr/hrv), <b>0818</b>	Nepali (ne/nep), <b>1405</b>	Tagalog (tl/tgl), <b>2012</b>
Amharic (am/amh), <b>0113</b>	Hungarian (hu/hun), <b>0821</b>	Norwegian (no/nor), <b>1415</b>	Tswana (tn/tsn), <b>2014</b>
Arabic (ar/ara), <b>0118</b>	Armenian (hy/hye), <b>0825</b>	Occitan (oc/oci), <b>1503</b>	Tonga (Tonga Islands) (to/ton), <b>2015</b>
Assamese (as/asm), <b>0119</b>	Interlingua (ia/ina), <b>0901</b>	Oromo (om/orm), <b>1513</b>	Turkish (tr/tur), <b>2018</b>
Aymara (ay/aym), <b>0125</b>	Interlingue (ie/ile), <b>0905</b>	Oriya (or/ori), <b>1518</b>	Tsonga (ts/tso), <b>2019</b>
Azerbaijani (az/aze), <b>0126</b>	Inupiaq (ik/ikp), <b>0911</b>	Panjabi (pa/pan), <b>1601</b>	Tatar (tt/tat), <b>2020</b>
Bashkir (ba/bak), <b>0201</b>	Indonesian (in/ind), <b>0914</b>	Polish (pl/pol), <b>1612</b>	Twi (tw/twi), <b>2023</b>
Belarusian (be/bel), <b>0205</b>	Icelandic (is/isl), <b>0919</b>	Pushto (ps/pus), <b>1619</b>	Ukrainian (uk/ukr), <b>2111</b>
Bulgarian (bg/bul), <b>0207</b>	Hebrew (iw/heb), <b>0923</b>	Quechua (qu/que), <b>1721</b>	Urdu (ur/urd), <b>2118</b>
Bihari (bh/bih), <b>0208</b>	Yiddish (ji/yid), <b>1009</b>	Rhaeto-Romance (rm/roh), <b>1813</b>	Uzbek (uz/uzb), <b>2126</b>
Bislama (bi/bis), <b>0209</b>	Javanese (jw/jav), <b>1023</b>	Rundi (rn/run), <b>1814</b>	Vietnamese (vi/vie), <b>2209</b>
Bengali (bn/ben), <b>0214</b>	Georgian (ka/kat), <b>1101</b>	Romanian (ro/ron), <b>1815</b>	Volapük (vo/vol), <b>2215</b>
Tibetan (bo/bod), <b>0215</b>	Kazakh (kk/kaz), <b>1111</b>	Kinyarwanda (rw/kin), <b>1823</b>	Wolof (wo/wol), <b>2315</b>
Breton (br/bre), <b>0218</b>	Kalaallisut (kl/kal), <b>1112</b>	Sanskrit (sa/san), <b>1901</b>	Xhosa (xh/xho), <b>2408</b>
Catalan (ca/cat), <b>0301</b>	Khmer (km/khm), <b>1113</b>	Sindhi (sd/snd), <b>1904</b>	Yoruba (yo/yor), <b>2515</b>
Corsican (co/cos), <b>0315</b>	Kannada (kn/kan), <b>1114</b>	Sango (sg/sag), <b>1907</b>	Zulu (zu/zul), <b>2621</b>
Czech (cs/ces), <b>0319</b>	Kashmiri (ks/kas), <b>1119</b>	Serbo-Croatian (sh/scr), <b>1908</b>	
Welsh (cy/cym), <b>0325</b>	Kurdish (ku/kur), <b>1121</b>	Sinhalese (si/sin), <b>1909</b>	
Danish (da/dan), <b>0401</b>	Kirghiz (ky/kir), <b>1125</b>	Slovak (sk/slk), <b>1911</b>	
Dzongkha (dz/dzo), <b>0426</b>	Latin (la/lat), <b>1201</b>	Slovenian (sl/slv), <b>1912</b>	

**Country/Area Code Table**

**Country/Area name, input code, Country/Area code**

Anguilla, <b>0109, ai</b>	Estonia, <b>0505, ee</b>	Macedonia, the Former Yugoslav Republic of, <b>1311, mk</b>	Singapore, <b>1907, sg</b>
Antigua and Barbuda, <b>0107, ag</b>	Finland, <b>0609, fi</b>	Malaysia, <b>1325, my</b>	Slovakia, <b>1911, sk</b>
Argentina, <b>0118, ar</b>	France, <b>0618, fr</b>	Malta, <b>1320, mt</b>	Slovenia, <b>1909, si</b>
Armenia, <b>0113, am</b>	Georgia, <b>0705, ge</b>	Mexico, <b>1324, mx</b>	Spain, <b>0519, es</b>
Australia, <b>0121, au</b>	Germany, <b>0405, de</b>	Moldova, Republic of, <b>1304, md</b>	Suriname, <b>1918, sr</b>
Austria, <b>0120, at</b>	Greece, <b>0718, gr</b>	Monaco, <b>1303, mc</b>	Sweden, <b>1905, se</b>
Azerbaijan, <b>0126, az</b>	Greenland, <b>0712, gl</b>	Montserrat, <b>1319, ms</b>	Switzerland, <b>0308, ch</b>
Bahamas, <b>0219, bs</b>	Grenada, <b>0704, gd</b>	Netherlands, <b>1412, nl</b>	Taiwan, Province of China, <b>2023, tw</b>
Barbados, <b>0202, bb</b>	Guyana, <b>0725, gy</b>	New Zealand, <b>1426, nz</b>	Tajikistan, <b>2010, tj</b>
Belarus, <b>0225, by</b>	Haiti, <b>0820, ht</b>	Norway, <b>1415, no</b>	Thailand, <b>2008, th</b>
Belgium, <b>0205, be</b>	Hong Kong, <b>0811, hk</b>	Pakistan, <b>1611, pk</b>	Trinidad and Tobago, <b>2020, tt</b>
Belize, <b>0226, bz</b>	Hungary, <b>0821, hu</b>	Peru, <b>1605, pe</b>	Tunisia, <b>2014, tn</b>
Bermuda, <b>0213, bm</b>	Iceland, <b>0919, is</b>	Philippines, <b>1608, ph</b>	Turkey, <b>2018, tr</b>
Brazil, <b>0218, br</b>	India, <b>0914, in</b>	Poland, <b>1612, pl</b>	Turkmenistan, <b>2013, tm</b>
Bulgaria, <b>0207, bg</b>	Indonesia, <b>0904, id</b>	Portugal, <b>1620, pt</b>	Turks and Caicos Islands, <b>2003, tc</b>
Canada, <b>0301, ca</b>	Ireland, <b>0905, ie</b>	Puerto Rico, <b>1618, pr</b>	Ukraine, <b>2101, ua</b>
Cayman Islands, <b>1125, ky</b>	Israel, <b>0912, il</b>	Romania, <b>1815, ro</b>	United Kingdom, <b>0702, gb</b>
Chile, <b>0312, cl</b>	Italy, <b>0920, it</b>	Russian Federation, <b>1821, ru</b>	United States, <b>2119, us</b>
China, <b>0314, cn</b>	Jamaica, <b>1013, jm</b>	Saint Kitts and Nevis, <b>1114, kn</b>	Uruguay, <b>2125, uy</b>
Colombia, <b>0315, co</b>	Japan, <b>1016, jp</b>	Saint Lucia, <b>1203, lc</b>	Uzbekistan, <b>2126, uz</b>
Croatia, <b>0818, hr</b>	Kazakhstan, <b>1126, kz</b>	Saint Vincent and the Grenadines, <b>2203, vc</b>	Venezuela, <b>2205, ve</b>
Cyprus, <b>0325, cy</b>	Korea, Republic of, <b>1118, kr</b>	San Marino, <b>1913, sm</b>	Virgin Islands, British, <b>2207, vg</b>
Czech Republic, <b>0326, cz</b>	Kyrgyzstan, <b>1107, kg</b>		
Denmark, <b>0411, dk</b>	Latvia, <b>1222, lv</b>		
Dominica, <b>0413, dm</b>	Liechtenstein, <b>1209, li</b>		
Dominican Republic, <b>0415, do</b>	Lithuania, <b>1220, lt</b>		
	Luxembourg, <b>1221, lu</b>		

Discover the benefits of registering your product online at  
<http://www.pioneer.co.uk> (or <http://www.pioneer.eu>)

## **PIONEER CORPORATION**

4-1, Meguro 1-Chome, Meguro-ku, Tokyo 153-8654, Japan

### **PIONEER ELECTRONICS (USA) INC.**

P.O. BOX 1540, Long Beach, California 90801-1540, U.S.A. TEL: (800) 421-1404

### **PIONEER ELECTRONICS OF CANADA, INC.**

300 Allstate Parkway, Markham, Ontario L3R 0P2, Canada TEL: 1-877-283-5901, 905-479-4411

### **PIONEER EUROPE NV**

Haven 1087, Keetberglaan 1, B-9120 Melsele, Belgium TEL: 03/570.05.11

### **PIONEER ELECTRONICS ASIACENTRE PTE. LTD.**

253 Alexandra Road, #04-01, Singapore 159936 TEL: 65-6472-7555

### **PIONEER ELECTRONICS AUSTRALIA PTY. LTD.**

178-184 Boundary Road, Braeside, Victoria 3195, Australia, TEL: (03) 9586-6300

### **PIONEER ELECTRONICS DE MEXICO S.A. DE C.V.**

Blvd.Manuel Avila Camacho 138 10 piso Col.Lomas de Chapultepec, Mexico,D.F. 11000 TEL: 55-9178-4270

K002\_B\_En

Published by Pioneer Corporation.

Copyright © 2008 Pioneer Corporation.

All rights reserved.